

SOLO PRO+

Original Instruction Manual

Version H



This document is applicable to the SOLOPro+ Inspection System.

A standard system and available options are covered by this document. Depending on your system configuration you may lack some of the features mentioned in this document.

Disclaimer

Hardware and software mentioned in this document are subject to continuous development and improvement. Consequently, there may be minor difference between the information in the document and the performance or design of the product. Specifications, dimensions and other statements in this document are subject to change without prior notice.

Minicam and its suppliers shall not be liable for any damages related to this software or hardware, or for any other damages whatsoever caused by the use of or inability to use any Minicam product. This is applicable even if Minicam has been advised of the damage risk. Under any circumstances, Minicam's entire liability shall be limited to replace such defective software or hardware that was originally purchased from Minicam.

Minicam Limited
Raven Locks, Ravenscraig Road, Bolton, United Kingdom, M38 9PU
Tel: +44 (0)1942 270524 Email: info@minicam.co.uk

www.minicamgroup.com

Company Registered in England & Wales • Company Registration No: 3728693

CONTENTS

WARRANTY	11
Limited Warranty.....	11
Extent of the Limited Warranty.....	11
Conditions of the Limited Warranty	11
Warranty Limitations	11
TEXT CONVENTIONS	12
Danger, Caution and Note	12
Bold Font.....	12
Lists.....	12
Menu Selections	12
PRODUCT DESCRIPTION	13
EC DECLARATION OF CONFORMITY	14
CE Declaration	14
SYSTEM OVERVIEW	15
WARNINGS, SAFETY MEASURES AND CARE	16
Before first use.....	18
Maintenance.....	20
Cleaning	21
General cleaning work	21
Preparing the CCU for First Use.....	23
Initial Inspection	23
Power Supplies.....	23
Battery Charging	23
Attaching the CCU to the Coiler	25
CCU210 - CONTROL UNIT	26
CCU Overview.....	27

Front view	27
Rear view.....	28
Switching the CCU On	29
Switching the CCU Off	30
Environmental Operating Temperature Consideration	30
DISPLAY FEATURES	31
Introduction.....	31
Status Icons	33
Internal Memory.....	33
SD/MMC Card Memory.....	33
External USB Memory.....	33
Internal and External Battery Status.....	34
Display Brightness.....	35
KEYBOARD	36
SURVEY KEYS	37
Meterage	37
Survey Features	39
RECORDING AND PLAYBACK KEYS	40
RECORDER CONTROL KEYS	41
Making a recording.....	41
Playing back a recording.....	41
Fast Forward.....	42
Fast Rewind	42
Zoom.....	42
Snapshot Capture	43
MEDIA KEYS	44
Data Transfer.....	44
Data Storage.....	44

Media Browser	46
Gallery Menu	46
To change the selected memory type	48
To view files contained inside the Daily Directory	49
To select one of the files for viewing	49
Show/Play Function	50
Copy function	50
Rename Function.....	51
Delete function	51
Un-mounting external memory	52
USB / SDHC Media Types	52
Camera Keys.....	54
Zoom.....	54

JOYSTICK **57**

CURSOR CONTROL KEYS **58**

FUNCTION KEYS **59**

SPECIAL KEYS **60**

Tools Key (Setup and Configuration).....	60
Screens Key.....	60
Sonde Key	60
Symbols Key.....	60
Help Key	60

TOOLS (SETUP AND CONFIGURATION) **61**

To Display the Setup menu	61
Files and Formats	63
Base filename.....	63
Video File Format.....	63
Theme	64
Licences.....	64

Time and Date.....	65
Camera / External Monitor.....	65
External Monitor.....	65
Colour Level.....	66
Brightness.....	66
Hue	66
Contrast	66
Power Saving.....	67
Camera and LCD Dimming.....	67
Automatic Shutdown	67
SONDE	68
Survey.....	69
WiFi	70
File Sharing	74
Email.....	74
WincanWeb.....	74
Share Status	75
Software Update.....	76
Service Centre.....	77
SCREENS KEY	78
SONDE KEY	79
SYMBOLS KEY	80
HELP KEY	84
Technical Details - CCU210	86
COILER	87
Connections and Descriptions.....	88
FRICTION BRAKE	89

Technical Details - SOLOPro+ 40m Coiler.....	91
Technical Details - SOLOPro+ 60m Coiler.....	91
Technical Details - SOLOPro+ 100m Coiler.....	91

CAM025 – SELF LEVELLING AXIAL CAMERA 92

Connections and Descriptions.....	93
Information and Care.....	93
Pressurisation	93
Cleaning	93
Maintenance.....	93
Technical Details CAM025	94

CAM026 – PAN & ROTATE CAMERA MODULE 95

Connections and Descriptions.....	96
-----------------------------------	----

PAN & ROTATE CAMERA OPERATION AND CONTROL 97

Basic camera operation	97
Home.....	97
Check Pressure	98
Camera Pressurisation	98
Driving the camera with pre-set movements	99
Information and Care.....	100
Pressurisation	100
Cleaning	100
Maintenance.....	100
Technical Details CAM026	100

REPORTING SOFTWARE 101

Principle	102
Basic Usage.....	103

QUICK USER GUIDE 104

Create a New Project.....	104
Choose Which Project to use	104

Create a Section in the Project	105
Select the Project Section to use.....	105
Enter the Section Header Information	105
Start Your Survey	106
Create a New Observation	107
Review Your Survey	108
End Your Survey	108
Create Your Report Documents	109

DETAILED USER GUIDE 110

Using Projects	110
The Projects List appears.....	110
Choose New Project or an Existing Project	111
If you chose to create a New Project	111
The Projects List appears	112
The project is now opened.....	113
Using Project Sections	114
The list of Existing Sections is shown	114
If you chose to create a new section	115
The Sections List appears	115
The Section is now opened	116
Preparing for the Survey	117
Entering Survey Header Information	117
For each Header Information item, you can choose whether.	118
Beginning the Survey	121
Performing the Survey.....	122
Creating Defect Observations	122
Ending the Survey.....	126
Reviewing the Survey	127
Editing an Existing Observation	128
Creating a New Observation	129
Creating Reports.....	130
Creating Reports for the Whole Project	130

Creating Reports for a Selected Section132

WEEE STATEMENT 134

BATTERIES 135

PRODUCT SERIAL NUMBERS 136

USEFUL INFORMATION 136

Warranty

Limited Warranty

Congratulations on the purchase of your new SOLOPro+ Inspection System. Our products are the result of many years experience and continuous developments. Conscientious manufacturing and checking are essential objectives in our company. Nevertheless failures cannot be excluded totally. If this occurs, you are covered by our generous warranty. Please consider that even the best products can only be durable and work properly with the correct handling and maintenance.

Extent of the Limited Warranty

Minicam warrants that your equipment will be in good working condition and free of defects in material and/or workmanship for a period of one year. If failure occurs, which is provable due to a defect in material and/or workmanship, we will remedy it free of charge during the warranty period. We reserve the right, at our option, to repair the equipment or to replace the whole unit or the faulty parts, or to refund the then current value of the equipment, if we are unable to repair or replace the unit. The warranty is a return to base warranty and we are not liable for any shipping costs.

Conditions of the Limited Warranty

Disassembling the camera, coiler, control unit or any part of the system, without approval of the manufacturer, is forbidden! Non-compliance of this direction will result in the loss of the warranty. The beginning of the warranty period is the date of delivery. This limited warranty does not cover damage due to improper treatment of the system, inadequate maintenance, alteration, repair, normal wear and tear or external causes like lightning, fire or frost. The warranty does not cover wear and tear parts like front camera lenses, O-rings, cable, push rod, rod rollers etc. If you require warranty service please return the system with the original invoice to your dealer or the nearest Minicam Service Centre. Equipment returned **must** be consigned carriage paid. We will **not** be liable for carriage costs.

Warranty Limitations

Our responsibility under this warranty is limited to repair, replacement or refund, as set forth above. Minicam is not responsible for direct, special, incidental or consequential damages resulting from any breach of warranty including lost profits, downtime, goodwill, damage to or replacement of equipment and/or property.

Text Conventions

Danger, Caution and Note

In this user manual the following symbols are used:



DANGER!

Danger means a potentially dangerous situation that can cause death or severe bodily injury. The icon identifies the type of risk.



CAUTION!

Caution means that the system or equipment can be damaged or data lost. The icon identifies the type of risk.



NOTE!

Notes are used to convey throughout this manual important information or guidance for system use.

Bold Font

Bold font is used for important words (For example: This **must not** be done in reverse order).

Lists

Lists are marked as follows:

- Item 1
- Item 2


Procedures that must be performed in a specific order appear in numbered lists like this:

- 1** Perform this step first.
- 2** Perform this step second.

Menu Selections

When describing control unit operation, sequential menu selections are described in the following format:

Tools > *Power Saving* > *Automatic Shutdown* > OK

This example describes pressing the Tools  key and selecting the Power Saving option, then Automatic Shutdown, and finally pressing the OK key.

Product Description

The inspection system SOLOPro+ is a modular system designed for, but not limited to, inspecting pipeline systems. Using colour cameras, optional modules and accessories, the SOLOPro+ platform offers everything needed for professional pipeline inspection of pipes equal to and greater than 150mm diameter.

Built using high quality materials and state-of-the-art technology the SOLOPro+ inspection system is a robust and powerful tool for use in harsh environments.

EC Declaration of Conformity

CE Declaration

We Minicam. Raven Locks, Ravenscraig Road, Bolton, United Kingdom, M38 9PU hereby declare that the product SOLOPro+ to which this declaration refers is in compliance with the following standards or standardizing documents:

EN61000-6-2:2005 Generic standards – Immunity for industrial environments.

EN61000-6-4:2007 Generic standards – Emission for industrial environments

The following are the stipulated operating and environmental conditions for said compliance:

Residential, business, commercial, small-company and light industrial environments.

This declaration is based on test report(s) of the relevant EMC testing laboratory

Authorised representative in the EU:

InPipe GmbH
Jägerwinkel 1a,
6991 Riezlern,
Austria

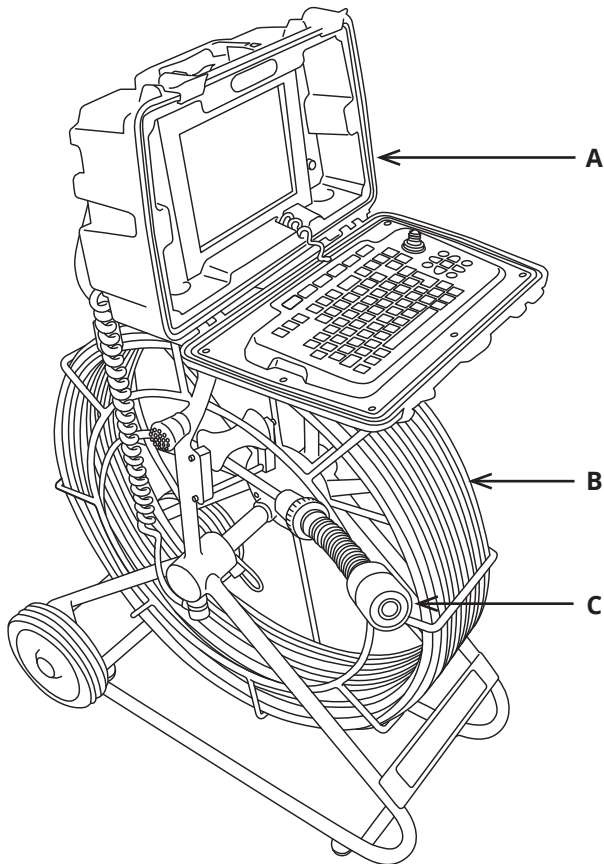
.

System Overview

The inspection system SOLOPro+ consists of the following main components:

- CCU (A)
- Coiler (B)
- Camera (C)

A typical configuration is shown in this illustration:



Warnings, Safety Measures and Care

Please read the safety measures closely and observe them. They preserve your own safety, the safety of co-workers as well as the prevention of damage to the SOLOPro+ inspection system and its components.



CAUTION!

The operator of the SOLOPro+ inspection system **must** be trained by either Minicam or one of its authorised representatives before using the system.



CAUTION!

Despite all of the safety functions built into the system, the operator is not exonerated in any way from his/her duty of care. Thus the user alone is responsible for any damage caused as a result of misuse.



CAUTION!

If the equipment is used in a manner not specified by the manufacturer, the protection provided by the equipment may be impaired.



DANGER!

Risk of deadly injuries from electrical current!

The mains plug and or IEC connector of the PSU is the supply isolation device and must be easily accessible.

- There are no user serviceable components within any module in the system.



DANGER!

Risk of deadly injuries from electrical current!

Only use an appropriately rated and approved cord set in accordance with the regulation of the country in which this system is used.



DANGER!

Risk of deadly injuries from electrical current!

Although the CCU and Coiler could be used in wet environments the **external PSU is for indoor use only** (as marked on its label) and must not be used in wet areas.



DANGER!

Risk of deadly injuries from electrical current!

Only the power supply supplied as part of the SOLOPro+ inspection system can be used and should **NOT** be replaced by any other.

Before first use

Please notice the following sources of risk for serious or deadly injuries:



CAUTION!

Risk of deadly injuries from electrical current!

- Ensure that no fluids can enter the control panel or penetrate the housing of the cable reel. If this happens, immediately disconnect the power supply and inform the appropriately trained staff or Minicam Service Centre.
- Ensure that the electrical connection cables are intact and that they cannot be bent or crushed. If you find cable damage, immediately disconnect the power supply and inform the appropriately trained staff or Minicam Service Centre.
- Work on the electronics, which are not covered in this document, **shall only** be carried out by trained specialist staff or a Minicam Service Centre.
- Maintenance and repair work, which is not covered in this document, shall only be carried out by trained specialist staff at a Minicam Service Centre.



CAUTION!

Risk of serious injuries by falling coiler!

When preparing the system for operation pay attention to the coiler position, that it is on a flat, level surface. When testing the rod pay-out, the coiler might fall into the man hole. Any person in the manhole may suffer serious injuries.



CAUTION!

Hazard of infection and contamination of fresh water!

Never alternate the use of the inspection system for inspections in wastewater and freshwater! Even a thorough cleaning of the system will not ensure sufficient protection against contamination. For inspections in wastewater and freshwater use a separate inspection system for each. Bacteria can lead to an infection. All individuals employed for the work must be advised of the hazards and must be instructed in the required safety measures.



NOTE!

Avoid physical damage!

The operator of the SOLOPro+ inspection system is responsible for the following aspects:

- Only use the inspection system for work that is appropriate to the specifications.
- Observe the operational requirements for this inspection system as described in this user manual.
- Keep the system clean. Observe the individual cleaning instructions for this purpose.

Maintenance

To ensure the maximum service life of the SOLOPro+ inspection system the individual modules and accessories belonging to the system have to be independently maintained and kept clean. Moving parts, in particular, can have improved operational life by frequent professional cleaning after inspections. Also, the risk to the operator of infection can be significantly reduced by using a cleaned system.

Take notice of the following comments on general maintenance:

- Keep the entire system clean and clean the system directly after each inspection.
- Thoroughly wash down the parts of the system that have come into contact with moisture and then dry them with a clean and dry cloth.
- Keep all electrical connections and contacts free of dirt, grease and moisture at all times.
- Never bend the cable of the system and avoid knots.
- Clean the cable with a rag when retracting.
- Regularly grease all exposed O-rings using O-ring lubricant as required in the maintenance instruction.
- Use only suitable display cleaners for cleaning the display as required in the maintenance instruction.
- Use only clean and dust free cloths for cleaning the display.
- Use water for cleaning without the addition of cleaning agents or solvents.

For detailed maintenance instructions for individual modules and accessories please read the comments in the description for each module. The specific maintenance work steps will also be explained.



NOTE!

The operator of the system is responsible for the proper disposal! See information on page 134 on the return of equipment at the end of the useful life.



IMPORTANT!

KEEP ALL ELECTRICAL CONNECTIONS AND CONTACTS FREE OF DIRT, GREASE AND MOISTURE AT ALL TIMES.

Cleaning

To minimise down time and subsequent repairs, it is necessary to keep your SOLOPro+ inspection system clean. Please follow the instructions below to help avoid disruption.



CAUTION!

Risk of fatal injuries caused by electrical current!

Ensure that no fluids can enter the control panel or penetrate the housing of the cable reel. If this happens, immediately disconnect the power supply and inform the Minicam Service Centre.



CAUTION!

Risk of fatal injuries caused by electrical current!

For all cleaning and maintenance work disconnect the system from the power supply.

General cleaning work



CAUTION!

High-pressure cleaners **must not** be used. It can cause considerable damage to the coiler, camera and other system components. Cleaning agents or solvents **must not** be used. These can damage the seals and other materials on the system.

Only clean water should be used.

- Clean the crawler and camera with water after the first inspection. Only after this should you loosen electrical connections.
- Immediately fit the protective caps after removing electrical connections.
- Check O-rings for damage and replace if necessary and greaseregularly with O-ring lubricant.
- Clean the cable reel and control unit with a damp cloth.
- Only clean the camera and light lenses with a specific lens cleaning cloth to prevent scratches.

Preparing the CCU for First Use

This section describes the process of getting the SOLOPro+ pipeline inspection system ready to use when you have just received it.

Initial Inspection

Inspect the shipping container for damage. If the shipping container or cushioning material is damaged, keep it until you have verified that the contents are complete and you have tested your SOLOPro+ Pipeline Inspection System mechanically and electrically.

The accessory case contains the accessories shipped with the SOLOPro+ Pipeline Inspection System. If the contents of the accessory case are incomplete or if the SOLOPro+ Pipeline Inspection System does not operate as you would expect, notify Minicam or your nearest Minicam Service Centre. If the shipping container is damaged or the cushioning material shows signs of stress, also notify the carrier. Keep the shipping materials for the carrier's inspection. Minicam or the Minicam Service Centre will arrange for repair or replacement without waiting for a claim settlement. If the shipping materials are in good condition, retain them for possible future use. You may wish to ship your SOLOPro+ Pipeline Inspection System to another location or return it to Minicam or your nearest approved Minicam Service Centre for service.

Power Supplies

The SOLOPro+ Pipeline Inspection System will operate from an external 12volt or 24volt DC power source or from internal batteries. The external power source will also charge the internal batteries when connected. Operating the unit while the batteries are being charged has no effect whatsoever on the time taken to recharge the batteries.

The external power source must be 12 volts DC nominal and the unit may consume up to 2.5 amps if operated while the internal batteries are being charged.

Battery Charging

When you receive your SOLOPro+ Pipeline Inspection System, the batteries will be in a partially discharged state. It is recommended that the unit is fully charged before use. The equipment may be used while the batteries are being charged from a mains or vehicle battery supply,

but should not be used on internal battery supply until the batteries have been fully charged. To charge the batteries, connect the power inlet socket on the rear of the unit to either a 12 volt DC mains power supply unit or the 12 volt DC cigarette lighter lead to a 12 volt DC supply. The batteries should be fully charged within 8 hours.

When the batteries are fully charged, the battery charger automatically switches off, preventing battery damage due to overcharging. Therefore the external power supply may be left connected and switched ON indefinitely with no ill effects.

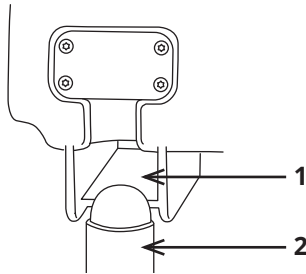


CAUTION!

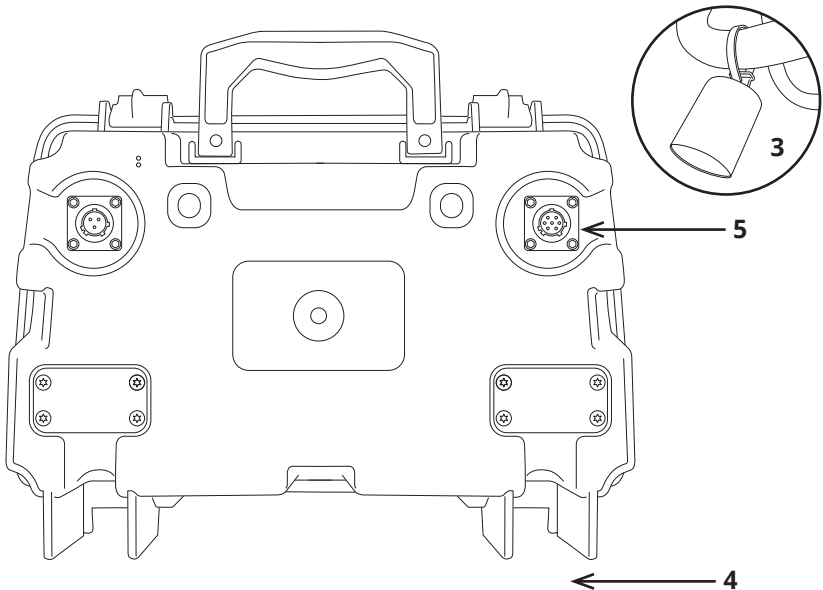
Never plug the control unit into a power supply source that is more than 24 volts DC nominal. Failure to ignore this will result in system damage.

Attaching the CCU to the Coiler

- 1 Position the CCU by aligning the location apertures (1) on the back of .. the CCU over and down onto the CCU location pins (2).



- 2 Remove the connector dust cover (3). Connect the curly lead (4) supplied with the coiler to the Coiler In connector (5) on the rear of the CCU.



NOTE!

The unit does not need to be installed on the coiler to operate. It can be operated stand alone for setting up, viewing recorded surveys and generating reports. It only needs to be installed on a coiler when actually performing a survey.

CCU210 - Control Unit

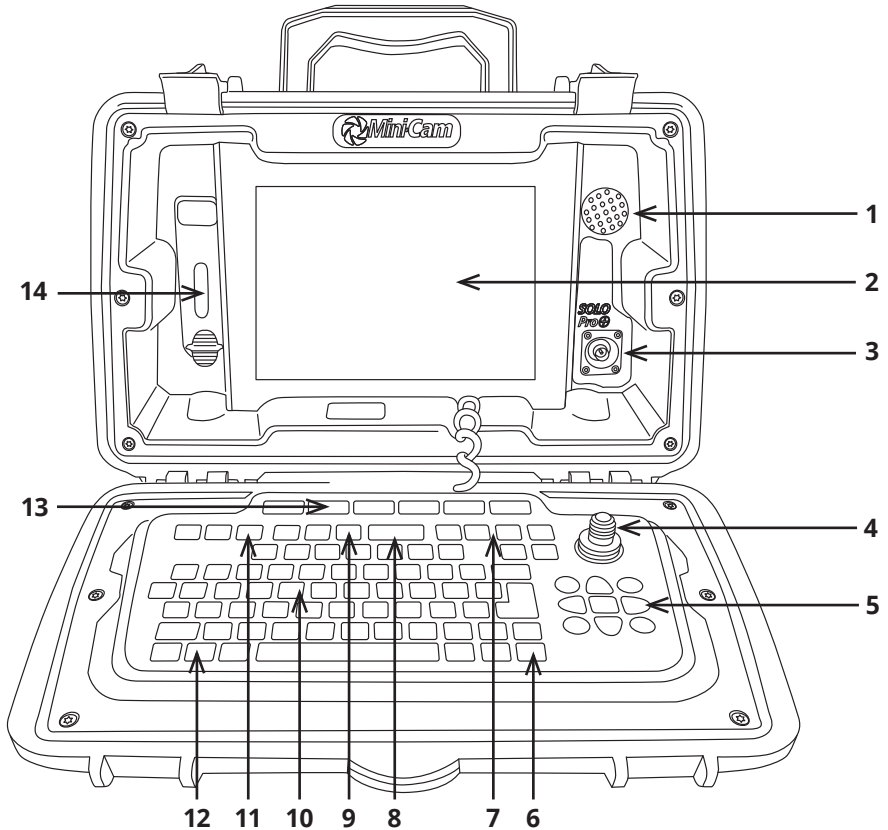
The control unit CCU210 is a robust and portable control unit for the SOLOPro+ system. It controls the functions and reports the status of the attached coiler and camera. It has the following features:

- Scalable internal solid state storage (32GB minimum)
- Data transfer via USB and SD card
- Sunlight readable display (SVGA 800x600 pixels)
- Video recording in MPEG-4 (WinCan compatible)
- Pictures saved in JPG format
- Customisable colour on screen text overlay
- Video output of live video with on-screen text
- Ergonomic design
- IP54 rated

The control unit CCU210 enables the operator to record video and photographic surveys, generate survey reports, and export the data via USB or SD card. The control unit can generate on screen text that is overlaid onto the recorded video in various colours and positions, allowing easy customisation.

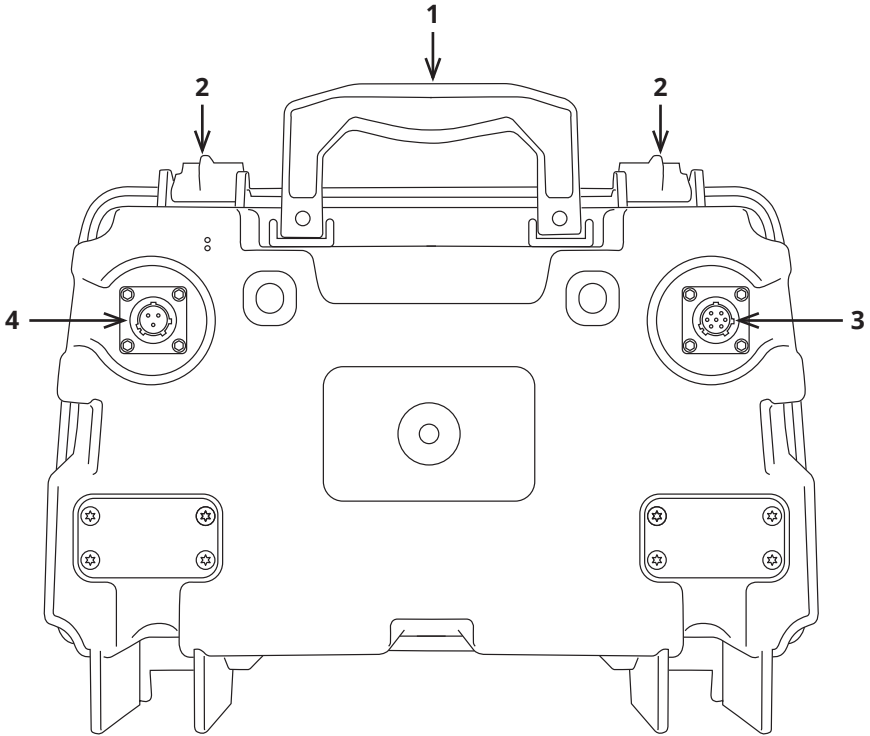
CCU Overview

Front view



- | | |
|--|------------------------------------|
| 1 Loudspeaker | 8 Power ON/OFF |
| 2 High Resolution TFT Screen
800 x 600 pixels | 9 Media Keys |
| 3 Video Output | 10 QWERTY style Keyboard |
| 4 Joystick | 11 Survey Keys |
| 5 Cursor Control Keys | 12 Special Function Keys |
| 6 Special Function Keys | 13 Multi-function "Hot" Keys |
| 7 Camera Keys | 14 Bung Flap for USB or SD
Card |

Rear view



- 1 Carry Handle
- 2 Lid Fastener Clip
- 3 Coiler Input
- 4 PSU (Power Supply Unit) Input

Switching the CCU On



NOTE!

If you are using the SOLOPro+ control unit with the Pan & Rotate Camera (CAM026) or Axial Camera (CAM025) the system must be fully connected before turning the system on.

The SOLOPro+ control unit will automatically detect whether a standard Self-levelling camera or a Pan & Rotate camera is connected. This is done at power up.

Should the SOLOPro+ control unit be powered up without being connected to the coiler without Pan & Rotate camera then it is assumed that a standard Self-Levelling Axial camera is attached. You will not be able to control the Pan & Rotate camera functions unless you reboot the control unit.

To switch the SOLOPro+ on, press the Power ON/OFF button on the keypad once only. The green coloured LED indicator will start to flash to show that the unit is initialising. This will take approximately 35 seconds. Nothing will appear on the screen until this process has completed.



Initialising



Initialised

When the SOLOPro+ control unit has initialised the green coloured LED indicator stops flashing and is permanently illuminated, and the Minicam splash-screen will show on the LCD display. When the splash-screen disappears you will be asked to press OK to acknowledge that you are familiar with the operational requirements of the equipment. Press OK to confirm

The live video picture from the push-rod camera will be shown, surrounded by a selection of icons showing system status, see page 31.



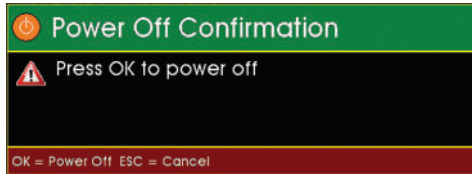
NOTE!

If a camera or coiler is not connected then the screen will

remain blue but the icons will still be displayed.

Switching the CCU Off

To switch the SOLOPro+ off, press the Power ON/OFF button and a dialogue will be displayed asking for confirmation to Power Off.



Press OK or the Carriage Return key and the unit will switch off in a controlled fashion.



NOTE!

Under extreme circumstances, the unit may fail to turn off in this fashion, in which case, press and hold the Power ON/OFF button for 10 seconds; when the power button is then released the unit will turn off.

Environmental Operating Temperature Consideration

The operating temperature of the SOLOPro+ is between -10° to $+40^{\circ}\text{C}$, not in direct sunlight.

Care should be taken during the operating of the CCU, especially in hot environments, to shade it from direct sunlight. Radiant heat from the sun can cause the equipment to heat up to temperatures exceeding $+60^{\circ}\text{C}$. All computers generate their own heat on top of the ambient temperature surrounding it.



NOTE !

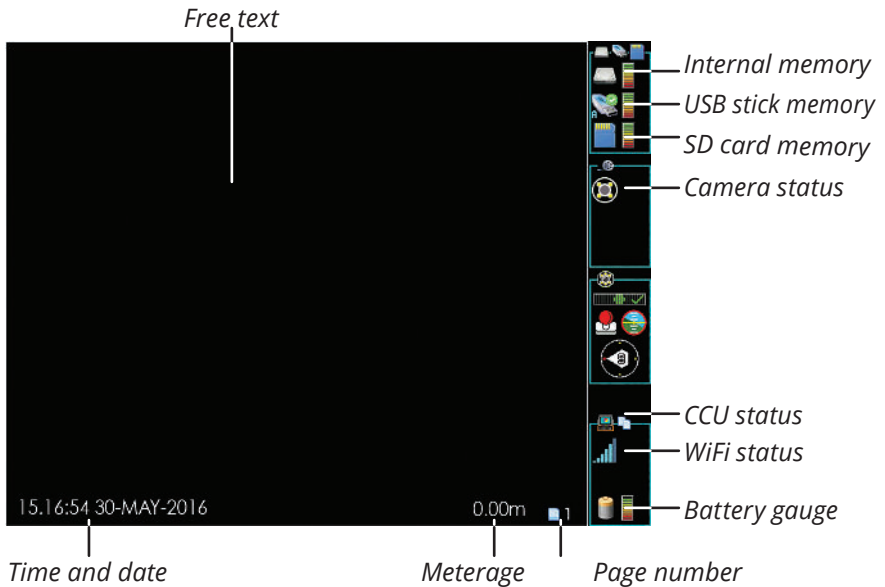
Using the equipment in direct sunlight can cause the electronics to overheat and shut-down unexpectedly. The equipment will not turn on again until it has been allowed to cool down.

Display Features

This section describes the characteristics of the front panel LCD display.

Introduction

The front panel of the SOLOPro+ unit houses an 20cm (8inch) Sunlight Readable Liquid Crystal Display (LCD) which is used to display live and recorded video and on screen menus. The display parameters such as contrast, brightness, colour and backlight intensity may be adjusted to suit the environment in which the unit is being viewed.



The live or recorded video picture is displayed in the left portion of the screen.

The right hand side is used to display a number of status icons which are seen on the screen but are not recorded.

There are areas of text at the bottom of the picture showing date, time and camera meterage. This text is recorded with the video picture. Text can also be entered manually anywhere on the display. This is free text and is used to annotate the survey and is recorded with the video picture. The colour and position of this text may be controlled with dedicated keys on the keypad.



NOTE! There is an area below the picture where the filename of recorded or played back video file is displayed. This is not recorded with the picture.

If Power Saving is enabled (see page 67), the screen backlight intensity will automatically reduce to a low level if the keypad is not used for a pre-set time period, returning to its normal intensity when any key is pressed.

Status Icons



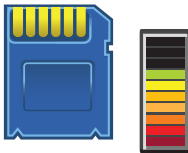
Camera Status

This shows whether or not there is a video signal available from the push-rod camera. If the camera is not connected or faulty, then a red cross appears over the icon.



Internal Memory

The gauge to the right of this icon shows the available capacity of the internal memory as a fraction of the total capacity. The used proportion of the internal memory is shown as the uncoloured bars at the top of the gauge, and the available portion is shown as the coloured bars at the bottom of the gauge.



SD/MMC Card Memory

The gauge to the right of this icon shows the available capacity of an SD (Secure Digital) or MMC (Multimedia Card) memory card in the front panel memory card slot. The used proportion of the SD or MMC memory is shown as the uncoloured bars at the top of the gauge, and the available portion is shown as the coloured bars at the bottom of the gauge.

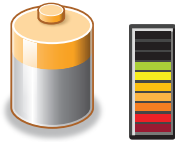


External USB Memory

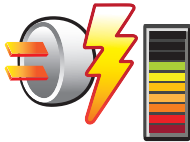
The gauge to the right of this icon shows the available capacity of a memory stick in the front panel USB socket. The used proportion of the USB memory is shown as the uncoloured bars at the top of the gauge, and the available portion is shown as the coloured bars at the bottom of the gauge.

Internal and External Battery Status

This icon shows whether an external power source is available (Power Plug icon) or if the CCU is operating on Internal batteries (Battery icon).



The gauge to the right of this icon shows the available capacity of internal batteries as a fraction of their total capacity. The available proportion of the internal battery is shown as the coloured bars at the bottom of the gauge, a fully charged battery shows all coloured bars, and a fully discharged battery shows no coloured bars.



The gauge to the right of this icon shows battery capacity available while the CCU is being operated on battery and the charged state when the CCU is being operated from an external power source. When connected to an external power source, the battery icon is replaced with a power plug icon and when the battery is charging a lightning strike symbol appears to the right of the icon.

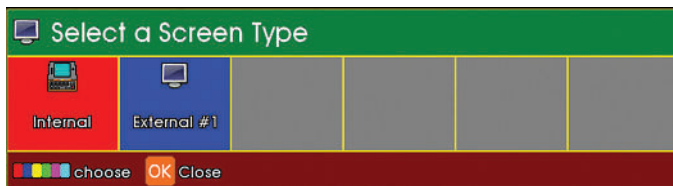
Display Brightness

The brightness, colour and backlight intensity of the internal (CCU) and external monitors can be adjusted to suit the environment in which the unit is being viewed:

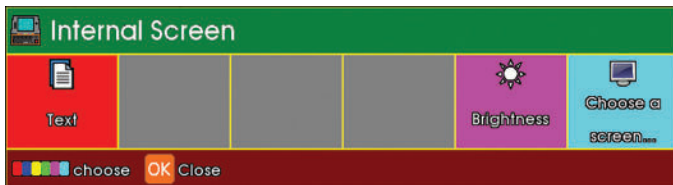
1 Press the Screens key.



Press F6 (Cyan key) Choose a Screen to select the Internal Screen (CCU) or an External Monitor



Press F1 (Red key) for Internal or F2 (Blue key) for External



Press F5 (Magenta key) to display the LCD Backlight status bar



Use the Left Arrow cursor key to decrease the brightness or the Right Arrow cursor keys to increase the brightness.

Keyboard

The keyboard is divided into clusters of keys and single keys as shown below.



- | | |
|--|--|
| 1 Survey Keys (page 37) | 8 Symbols Key (page 80) |
| 2 Recording and Playback Keys
(see page 40) | 9 Help Key (page 84) |
| 3 Media Keys (see page 44) | 10 Tools Key (page 61) |
| 4 Function Keys (see page 59) | 11 Text Entry Keys |
| 5 Camera Keys (see page 54) | 12 Sonde Activation Key (page 79) |
| 6 Joystick (see page 57) | 13 Screens Key (page 78) |
| 7 Caps Lock Key | 14 Cursor Keys (see page 58) |

Survey Keys

The Survey keys cluster features three keys:

A. Meterage B. Text C. Survey Features




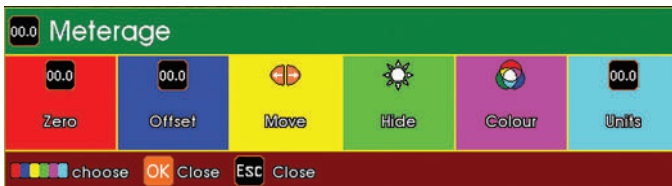
(A)

(B)

(C)

Meterage

1 Press the Meterage key. 



The meterage functions will be displayed on screen

- 2 Select the required function:
- Zero F1 (Red key) Resets the meterage to 00.0.
 - Offset F2 (Blue key) Sets the meterage to your preferred value.
 - Move F3 (Yellow key) Use the cursor control Left Arrow, Up Arrow, Right Arrow and Down Arrow to re-position the on-screen text.

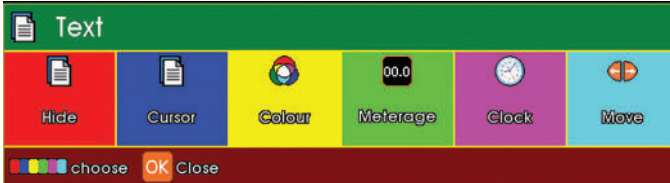


- Hide F4 (Green key) Hides or shows the meterage from the display.
- Colour F5 (Magenta) Change the colour and/or outline of the screen text.
- Units F6 (Cyan) Set the units of measure:

0.00/ 0'.0"/0.00m/0.00cm.

Text

1 Press the Text key.



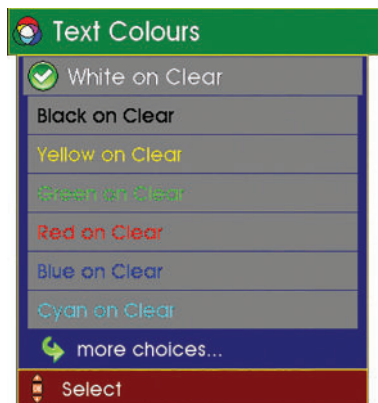
The text functions will be displayed on screen

2 Select the required function:

Hide F1 (Red key) Hides or shows the meterage from the display.

Cursor F2 (Blue key) Hides or shows the cursor from the display.

Colour F3 (Yellow key) Select the desired text colour from the drop down menu.



Meterage F4 (Green key) Hides/shows the meterage from the display

Clock F5 (Magenta key) Hides/shows the clock from the display

Move F6 (Cyan key) Use the cursor control Left Arrow, Up Arrow, Right Arrow and Down Arrow

to reposition the on-screen text.

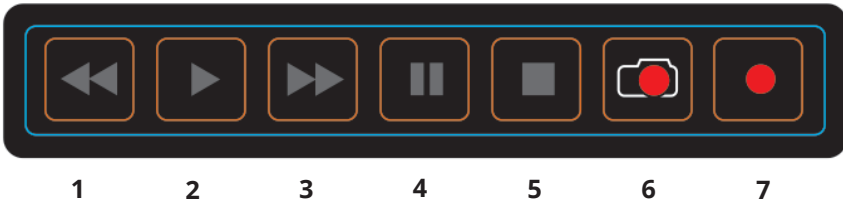


Survey Features

The Survey Folder key is used to start a *ProPipe* survey (see page 143) or *WinCan* survey (see page 106).

Recording and Playback Keys

These keys control the recording and playback of video files



- 1 Rewind
- 2 Start
- 3 Fast Forward
- 4 Pause
- 5 Stop
- 6 Snapshot
- 7 Record

The keys shown above are described in more detail on the following pages.


Recorder Control Keys






This section describes the functions of the Recorder Control Keys and how these can be used to make recordings and control the playback of stored surveys.



Making a recording

To start the recording of a survey.

Press the Record key 

This will cause a recording to commence. The filename will be displayed at the bottom left of the screen together with an icon to show which memory type it is being recorded on. The elapsed time of the recording in minutes and seconds is displayed at the bottom right of the screen. A red dot  to indicate that a recording is taking place is displayed at the right of the screen




At any time the Pause key  may be pressed which will pause the recording, although the display will continue to show the live video and a Pause symbol  will be displayed, and flashes,  to show that the recording has been paused. To resume the recording press either the Pause key  or the Record key .

To stop the recording, Press the Stop key . This will cause the record filename, the recording elapsed time and the record button to be removed from the display, and a pale blue rotating 'progress' circle  may appear on the right of the screen to show that the file is being saved and closed.








NOTE! While the progress icon is displayed, no action, such as removing a USB memory stick or an SD card, should be attempted as it may result in corrupted or bad files.

Playing back a recording



To play back a recording, press the Gallery Browser  key to select the .avi or .mp4 file which you wish to view, then press  or press the Play Key 


The selected video file will now start to play and the filename will be displayed at the bottom left of the screen together with an icon to show which memory type it was recorded on.



In the centre bottom of the screen, a progress bar is displayed to show the current position in the total length of the recorded file. To the right of this is the total length of the recording (in minutes and seconds) and to the right of this is the elapsed time into the recorded file (also in minutes and seconds), and finally to the right of this is a pale blue Play symbol .

Once again, the Pause Key  may be pressed which will pause the playback and the picture on the screen will become stationary and the Pause Symbol  will flash to show that the playback has been paused. To resume playback of the recording press either the Pause key  or the Play key .



Fast Forward

During playback, the playback speed may be increased by pressing the Fast Forward key . Pressing this key once will cause the playback speed to advance at twice the normal speed (x2). Press this key a second time to increase the playback speed to 5 times normal speed (x5) and a third time to increase to the fastest playback speed of 12 times normal speed (x12). To return to normal playback speed press Play key .

To reduce the fast forward speed, press the Rewind key , each press reducing the playback speed from 12x to 5x to 2x and finally back to normal playback speed.

While the recording is fast forwarding, the Play symbol  on the screen becomes a Fast Forward symbol  with the fast forward speed being displayed to the right as x2, x5 or x12.

Fast Rewind

Fast Rewind is similar to fast forward except that there are only two rewind speeds, times five (x5) and times 12 (x12). While the recording is rewinding, the Play symbol  on the screen becomes a Rewind symbol  with the rewind speed being displayed to the right as x5 or x12.

Zoom

The survey picture may be zoomed in to see small details in the survey.

To zoom in press the Zoom key (see page 54). Pressing this key once will zoom in by a factor of 1.5, pressing a second time will increase the zoom ratio to 2 and pressing a third time will increase it to 3. Pressing this key a fourth time returns the picture to normal view.

At each stage of zoom, the area of the total survey picture which is being viewed on the screen is shown as a red box on a white background in the bottom left of the picture.




The area which is viewed in zoom mode can be moved around the survey picture using the cursor control Left Arrow, Up Arrow, Right Arrow and Down Arrow keys.



If the survey picture is zoomed in during a recording then the zoomed view will be recorded together with the red on white symbol to show which area of the survey picture is being viewed.

Snapshot Capture

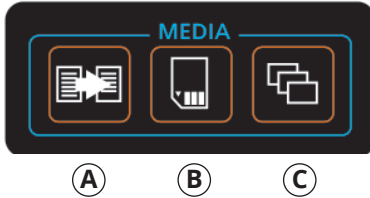
While a survey is being recorded or played back, a still image may be captured and stored by pressing the Snapshot key . The still image will be stored as a .jpg still image using the default filename format.

Snapshots may be taken while recording or playing back a survey. If a snapshot is taken while the picture is zoomed in (see page 43), then it will be the zoomed image which is stored as the snapshot.

Media Keys

The Media keys cluster features three keys:

- A Data Transfer (currently inactive)
- B Data Storage
- C Media Browser



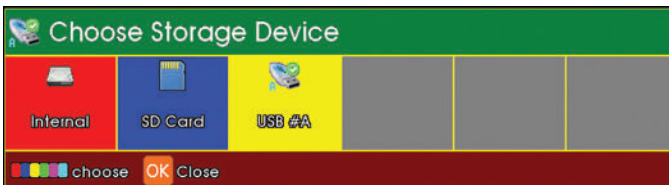
Data Transfer

The Data Transfer function is currently inactive.

Data Storage

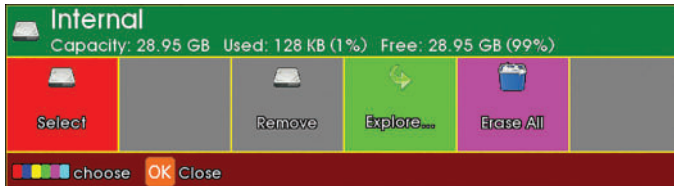
The Data Storage function allows the user to store data on the internal memory of the CCU or on external storage using a USB stick or SD Card.

- 1 Press the Data Storage key.

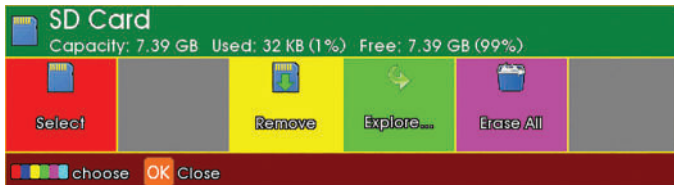


The dialogue will show the internal memory of the CCU plus any mounted external memory eg: SD Card and/or USB Stick.

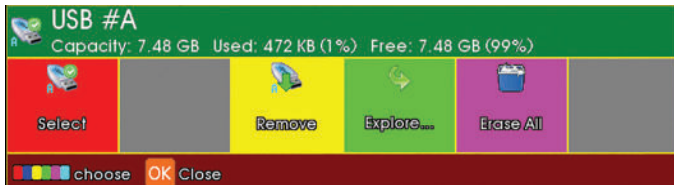
2 Select Internal to view the options available for the Internal Memory:



Select SD Card to view the options available for the SD Card:



Select USB to view the options available for the USB Stick:



The functions available for each storage option are as follows:

Remove

Select Remove for safe removal of the SD Card or USB stick to prevent loss

of data. Then manually remove the SD Card or USB stick from its slot.

Explore

Select Explore to view all stored video and data files.

Erase All

Select Erase to erase all stored video and data files.

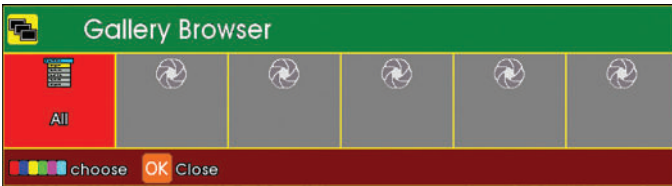
Media Browser

This section describes how the key is used to access and manipulate recorded survey video files.

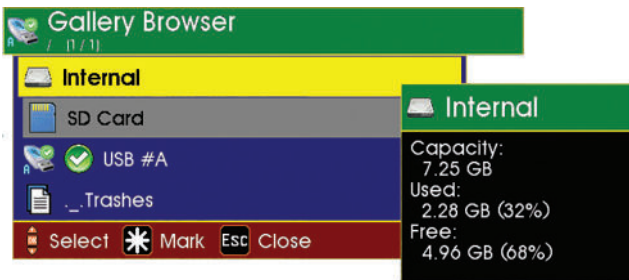
Gallery Menu

1 Press the Media Browser  key

2 The Gallery Browser dialogue will be displayed



Press F1 (Red key) to display a menu that shows which of the three main memory types is being used and the contents of that memory type:



The three memory types are:-

- 1 Internal memory - usually used to record video surveys.
- 2 USB memory - usually a memory stick plugged into the front panel connector.
- 3 SD card memory - an SD card inserted into the front panel slot

Surveys are stored in a Daily Directory which is automatically created when a survey is recorded or a picture is taken. This allows you to keep all the surveys organised by the day they were done. This is especially useful, for instance, at the end of the day when you want to copy all of the day's work from the CCU to an external media to hand into the office.

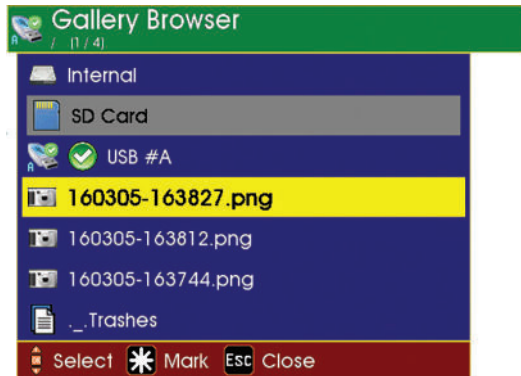
Daily Directories are named by the date they were created in the format:

YYMMDD, e.g 110702_Survey.dgs

By default all Daily Directories and surveys are recorded onto internal memory and are then copied to an SD card or USB stick using the Gallery Copy function.

However, surveys may be recorded directly to an SD card or USB stick by selecting either of these as the default recording memory in the Gallery menu.

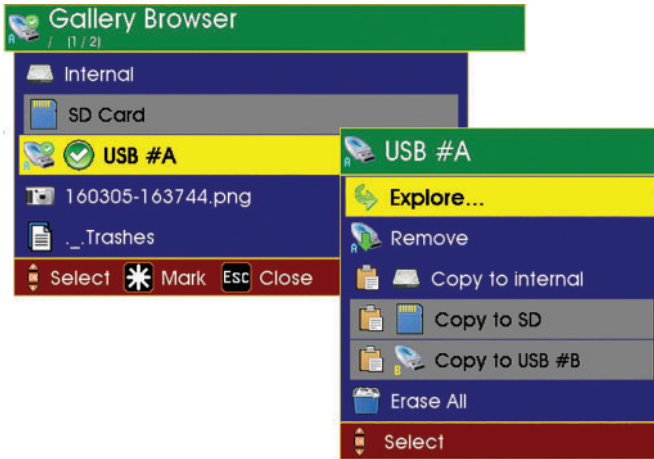
The memory types are shown in the gallery in the following way:-



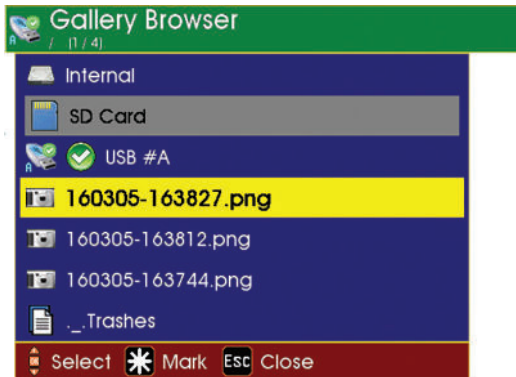
The tick next to one of the memory types shows which one is selected for viewing and where the video files are automatically recorded to.

To change the selected memory type

- 1 Move the cursor so that a new memory type is highlighted in yellow.
- 2 Press OK and a menu is displayed with an Explore option.



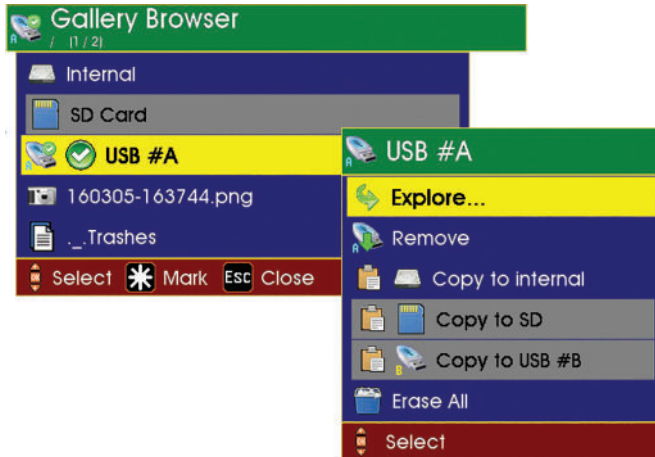
- 3 Select this option and the new memory type will now be ticked to show it is now the default memory type.



The daily directories or video files in the selected memory type are then displayed in the order in which they were recorded (most recent at the top of the list).

To view files contained inside the Daily Directory

- 1 Highlight the file to be viewed and press OK
- 2 Select Explore.



To select one of the files for viewing

- 1 Highlight the file and press OK. A sub-menu is displayed as shown below:

Explore (see note below)
Copy to
Rename
Delete


- 2 Select **Explore**. This will show video files within the Daily Directory



NOTE: If the selected file is a .jpg picture, then the first menu entry is Show and if the selected file is an .mp4 or .avi movie file, then the first menu entry is Play.

Show/Play Function

The Show/Play menu entry will be highlighted in yellow. Press OK and the selected video will play or picture will be displayed.

An alternative way to play a video file is to press the Play key  on the control section of the keyboard, which will play the selected file instantly.


The file list is able to display 7 files at a time, if more than 7 files have been stored in the selected memory, then a Next Page menu item is shown at the bottom. The next page of files may be selected by moving to this menu item and pressing OK.

Similarly if you wish to navigate to the previous list of files, move to the Previous Page menu item and press OK.

Copy function

With the copy function the user can copy all files from one memory type to another, e.g. Copy all files from the Internal memory to the external USB memory.

It is also possible to copy a daily directory or individual file directly to another media.

To use this function open the Gallery Browser  and highlight the source memory, daily directory, or file then press OK. You will now be presented with the option to copy directly to another media, e.g. Copy to SD or Copy to USB. Highlight the appropriate media and press OK.

If copying all files you will now be prompted to press Y to confirm copying all files.

A progress bar will show the status of the transfer. When you are copying multiple files the system will show you overall progress and individual file progress on two separate progress bars.

Rename Function

This function allows the user to change to file name to something more useful or meaningful.

However, it does not change the entire file name. It only changes the name after the time and date stamp of the survey. This is to keep the files in order.

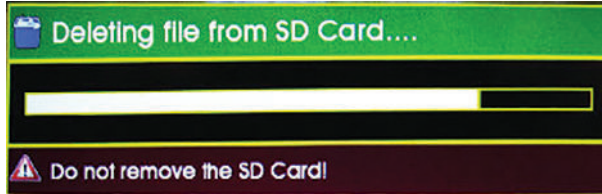
Delete function

The Delete function permanently removes the selected file from the system.

If this function is selected then a window is displayed asking the user to confirm that this file is to be deleted by pressing the Y key.



NOTE: The Delete function may take a short time to execute so to show how much of the function has been completed a progress bar is displayed on the screen.



Un-mounting external memory

Before any external memory device (SD card or USB memory stick) is removed from the unit, it must be un-mounted.

To do this open the Gallery Browser  and select the memory which needs to be removed using the Up Arrow and Down Arrow keys. Press OK and select the Remove option.

During the un-mounting process, the memory icon next to the fuel gauge will show a downward pointing, green arrow with a red cross over it to show that the memory should not be removed. For the SD memory and USB memory the icons will look like this:



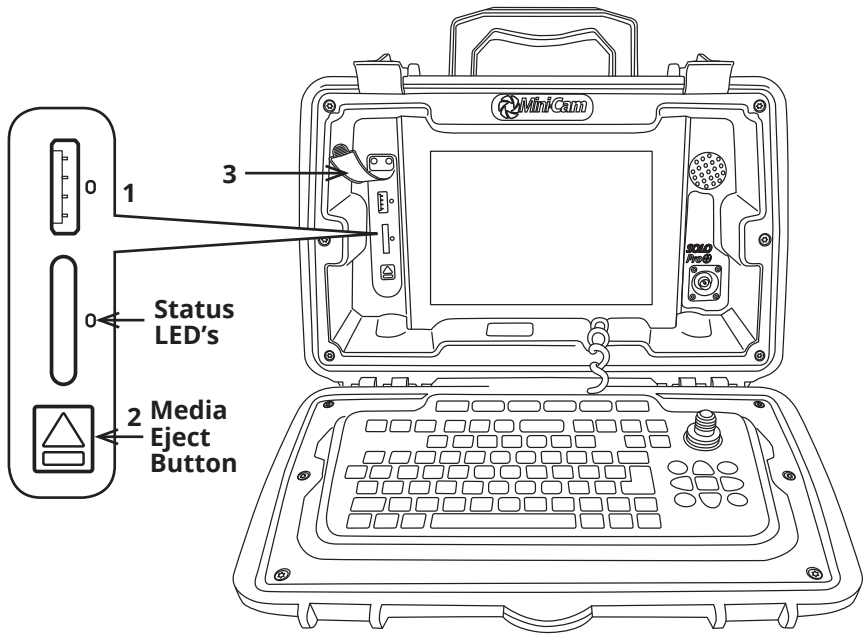
When it is safe to remove the selected memory, the red cross will disappear so only the green arrow will remain, indicating that the memory may be removed. For the SD memory and USB memory the icons will look like this:-



CAUTION: It is very important that external memory is un-mounted before it is removed. If this is not done and the memory is simply unplugged, then files on the memory device may become corrupted.

USB / SDHC Media Types

Due to variations in USB / SD Flash media technology, Minicam cannot guarantee that all types and sizes will function correctly. For USB we recommend a read speed of a least 15MB/s and a write speed of a least 8MB/s. For SDHC we recommend a card of CLASS 5 or higher. Therefore it is recommended that they are purchased directly from Minicam. Please contact us for further information. Contact details can be found on page 3



1 External media – USB and SD card slots

a External media status LED's.

- Blue – Media is plugged in but is not in use.
- Orange blinking – Media is currently selected and in use.
- Green – Media is safe to remove from the control unit.
- Red – Media is plugged in but is faulty.

2 External media eject button

- a** Press this button for 1 second and release. This will instruct the control unit that you wish to unmount the external storage media. When the LED status indicators are green it is safe to remove the media.

3 External media protection cover

- a** To protect the connectors from dirt and moisture.



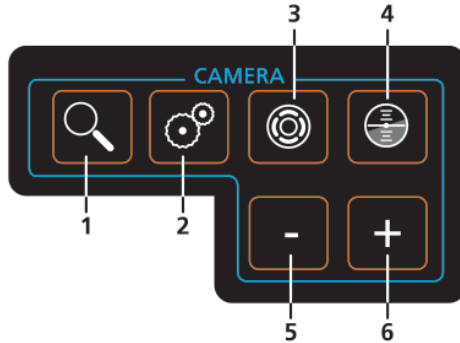
NOTE!

Always fit the external media protection cover (**3**) into position to protect from ingress of dirt and moisture.


Camera Keys

The Camera keys cluster features six keys:

- 1 Zoom
- 2 Camera Sweep
- 3 Illumination
- 4 Home
- 5 Focus Minus
- 6 Focus Plus



Zoom

Press the Zoom key. 

Pressing this key once will zoom in by a factor of 1.5, pressing a second time will increase the zoom ratio to 2 and pressing a third time will increase it to 3. Pressing this key a fourth time returns the picture to normal view. At each stage of zoom, the area of the total survey picture which is being viewed on the screen is shown as a red box on a white background in the bottom left of the picture. The area which is viewed in zoom mode can be moved around the survey picture using the cursor control Left Arrow, Up Arrow, Right Arrow and Down Arrow keys.



If the survey picture is zoomed in during a recording then the zoomed view will be recorded together with the red on white symbol to show which area of the survey picture is being viewed.



Camera Sweep

Press the Camera Sweep key.



The menu displays the camera sweep options:

Press F4 (Green key) to sweep camera clockwise.

Press F5 (Magenta key) to sweep camera anti-clockwise.

Illumination

Press the Illumination key.



The Camera Illumination status bar will be displayed. Use the cursor control Left Arrow key to decrease the illumination. Use the cursor control Right Arrow key to increase the illumination.



Home

Press the Home key.



The camera head returns to the home position.

Focus

Press the Plus key or Minus key.



adjust the sharpness of the image on screen.

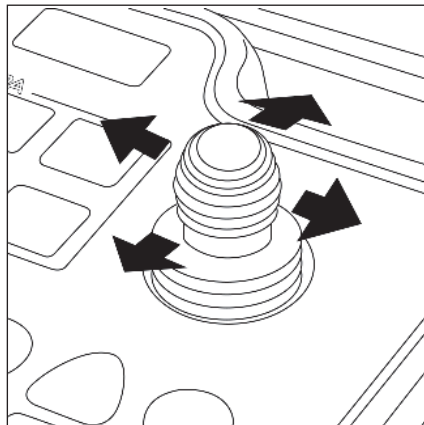
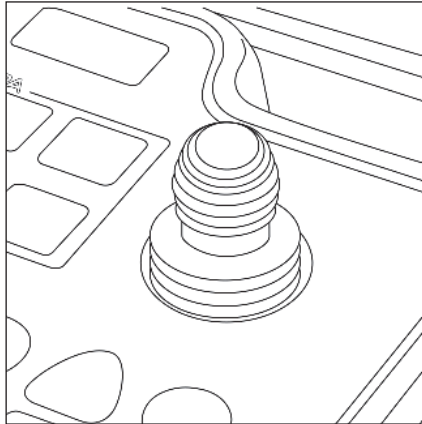
Joystick

The joystick is located at the top right-hand side of the keyboard. The joystick only becomes active when CAM026 is connected to the system (see page 97).

The functions of the joystick are as follows:

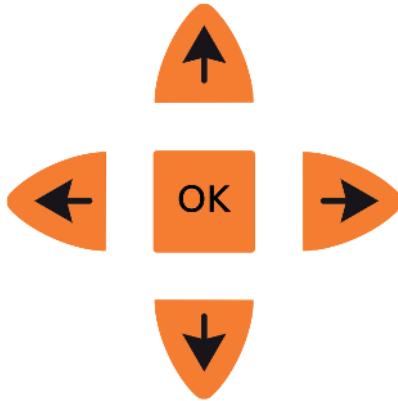
Move the joystick Left or Right to perform an 360° endless rotation of the camera.

Move the joystick Up or Down to pan the camera 135° + or - (Plus or Minus).



Cursor Control Keys

The cursor control consists of five keys; Left Arrow, Up Arrow, Right Arrow, Down Arrow and OK. These five keys are used to move the cursor around the screen after entering text and to move around and highlight menus in the gallery and set-up menus.



Function Keys



Located at the top of the keyboard, the Function keys or “Hot Keys” are user friendly multi-function keys used to navigate the menu dialogue screens for the various features of the system. The easy-to-use colour-coding matches the key on the keyboard to the option on the screen menu. The colours of the keys are referred to in this manual as shown below:



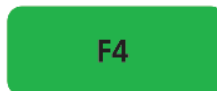
F1 Red key



F2 Blue key



F3 Yellow key



F4 Green key



F5 Magenta key



F6 Cyan key

Special Keys

Tools Key (Setup and Configuration)



Press the Tools key and the Setup and Configuration menu will be displayed. The functions of this menu are described on page 61.

Screens Key



Press the Screens key and the Screens menu will be displayed. The functions of this menu are described on page 78.

Sonde Key



Press the Sonde key and the Sonde menu will be displayed. The functions of this menu are described page 79.

Symbols Key



Press the Symbols key and the Symbols menu will be displayed. The functions of this menu are described on page 80.

Help Key



Press the Help key and the Help menu will be displayed. The functions of this menu are described on page 84.

Tools (Setup and Configuration)

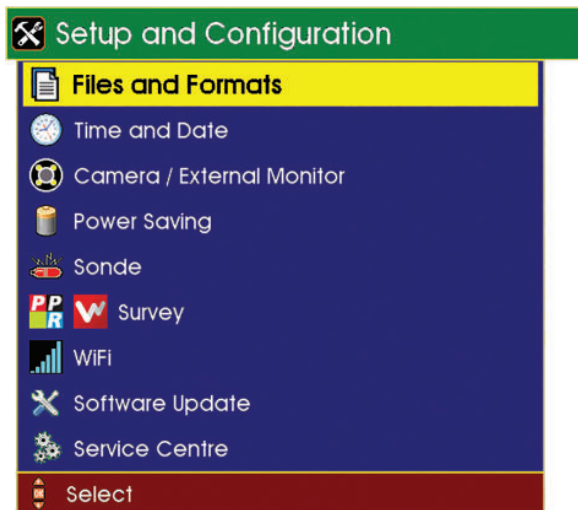
The SOLOPro+ CCU can be configured for your specific requirements using the setup menus described in this section.

To Display the Setup menu

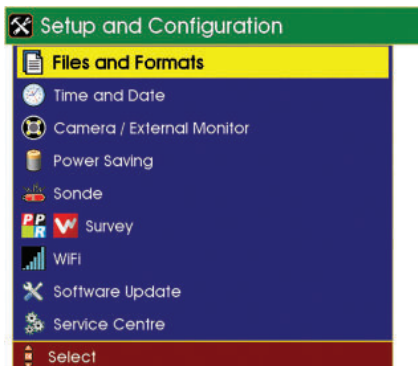
1 Press the Tools key.



The Setup and Configuration menu will be displayed.



A map of the above menu is shown on the next page.



Sub menus are as follows:

Files and Formats

- >Base Filename
- >Video File Format
- >Theme
- >Licences

Time and Date

Camera / External Monitor

- >Colour Level
- >Brightness
- >Hue
- >Contrast

Power Saving

- >Camera and LCD Dimming
- >Automatic Shutdown

Sonde

- >Frequency

Survey

- >ProPIPE
- >WinCan

WiFi

Software Update

- >Software Update Browser

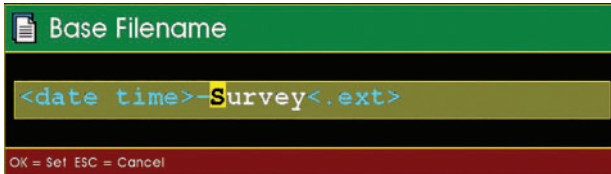
Service Centre

Each of the setup functions will be described in detail on the following pages.

Files and Formats

This menu entry allows the user to select the default filename and file format.

Base filename

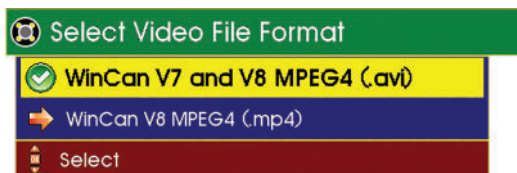


When recording a survey, SOLOPro+ automatically creates a filename which is made up from the date (in YYYYMMDD format) followed by an underscore character followed by the time (in HHMM format) followed by the default base filename. Thus the default filename can be set to be the company or industry standard and all recorded files will automatically be given a unique filename based on this default.

Example filename:
160630_1059-Minicam.avi

This indicates that the file was recorded on the 30th June 2016 and started at 10:59. Minicam is the default filename and .avi shows that the file is in the motion video AVI format

Video File Format



AVI (MPEG4) is a motion video file which can be played back using WinCan V8, WinCan VX, Windows® Media Player and most other third party readers.



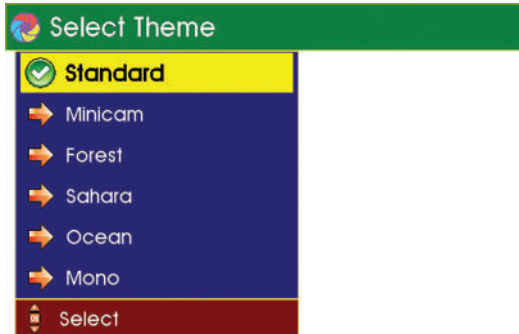
NOTE !

Please note that an additional codec may need to be installed

on the host PC or Mac to play back video files. We recommend *DivX*.

Theme

This feature allows the user to select the colour theme used for the menu system on SOLOPro+.

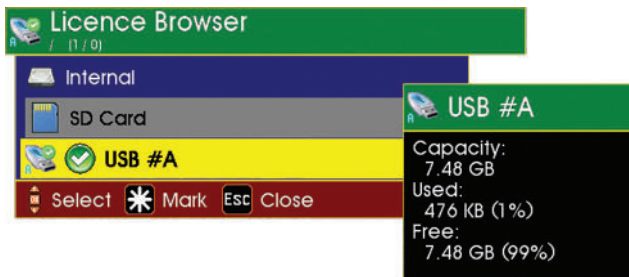


Licences

This feature allows the user to install or view currently installed licences on the SOLOPro+. Certain features require a licence to be installed to activate them i.e. ProPIPE Report and WinCan.



Select the required View or Install option:



Time and Date

This menu allows the time and date to be set for the local area. Having selected the Time and Date option, use the cursor control Left Arrow, Up Arrow, Right Arrow and Down Arrow to change the highlighted number then move the cursor Left Arrow or Right Arrow to move from one field to another.

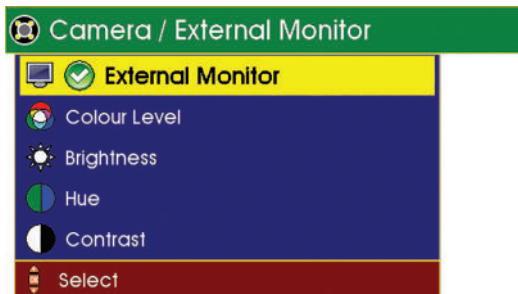


When you have set the date and time press OK to save and return to the setup menu.

Camera / External Monitor

External Monitor

This is an optional extra (purchased separately) on SOLOPro+. If installed you can turn the video output ON/OFF by selecting this option. When ON a green tick sits alongside this option to signify that it is active.



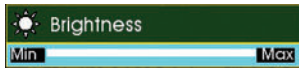
Colour Level

Adjusts the colour level of the picture. Press the Left Arrow or Right Arrow cursor key to change the setting. Press '0' to reset to default setting.



Brightness

Adjusts the Brightness of the picture. Press the Left Arrow or Right Arrow cursor key to change the setting. Press '0' to reset to default setting.



Hue

Adjusts the Hue of the picture. Press the Left Arrow or Right Arrow cursor key to change the setting. Press '0' to reset to default setting.



Contrast

Adjusts the Contrast of the picture. Press the Left Arrow or Right Arrow cursor key to change the setting. Press '0' to reset to default setting.



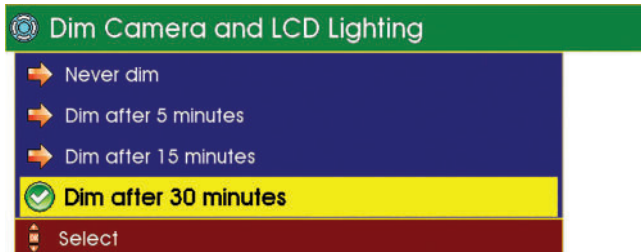
These settings do not affect the display of the menus on the screen, only the video from the camera is affected.

Power Saving

This menu allows the user to set the power saving features of the SOLO-Pro+.



Camera and LCD Dimming



The camera illumination and LCD backlight will dim after a period of inactivity.

The options are: Never / 15 / 30 minutes.

Automatic Shutdown



When the SOLOPro+ is powered only by internal batteries this feature will power down the SOLOPro+ after a period of inactivity.

The options are: Never / 5 / 15 / 60 minutes.

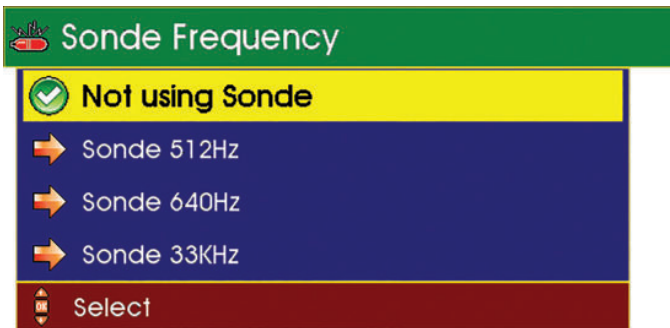
Sonde

This feature allows the user to set the Sonde frequency.

- 1 Select Survey from the Setup and Configuration drop-down menu
- 2 Select the required Sonde frequency from the drop-down menu.

The Sonde frequency options are:

512Hz / 640Hz / 33KHz



The Sonde frequency can also be set using the Sonde

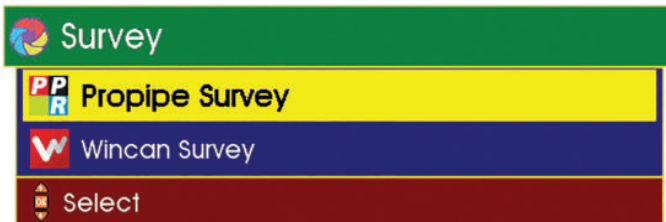


Key see page 79.

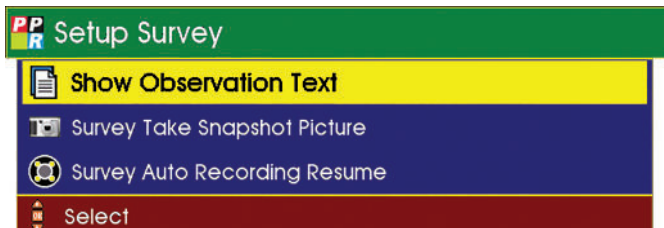
Survey

This feature allows the user to show observation text and take snapshot pictures.

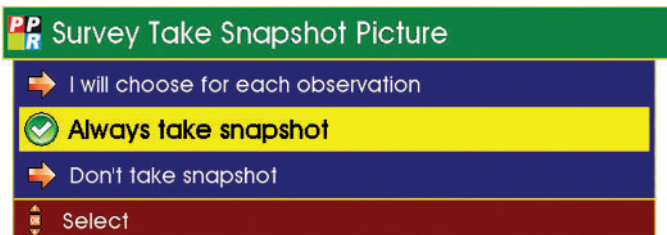
- 1 Select Survey from the Setup and Configuration drop-down menu (see page 61).
- 2 Select the required software: ProPIPE or WinCan.



- 3 Select the required option eg: Survey Take Snapshot Picture.



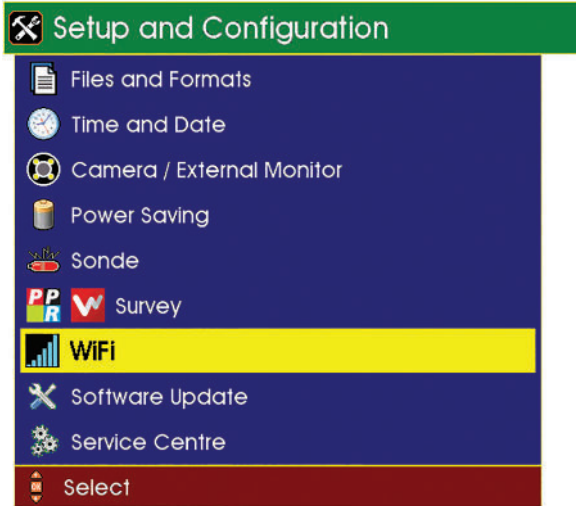
- 4 Select the required option. eg: Always take snapshot



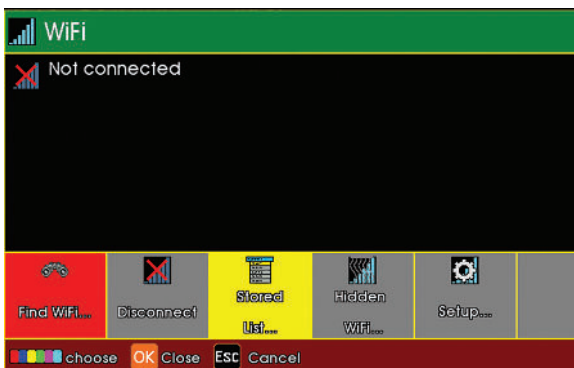
WiFi

This feature allows the user to connect the CCU to WiFi.

- 1 Select WiFi from the Setup and Configuration drop-down menu page 61.



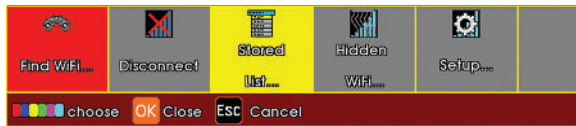
- 2 A menu will be displayed giving options to connect to WiFi.



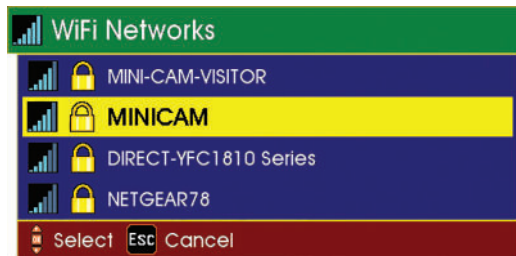
3 Select **Stored** F3 (Yellow Key) to view stored network URLs (addresses).



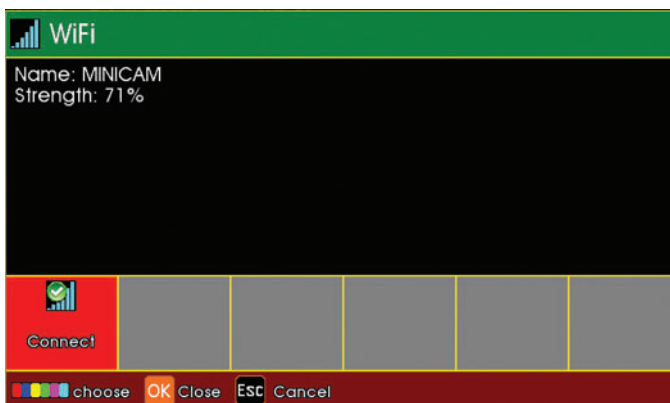
4 Select Find WiFi... F1 (Red Key) to search for available networks.



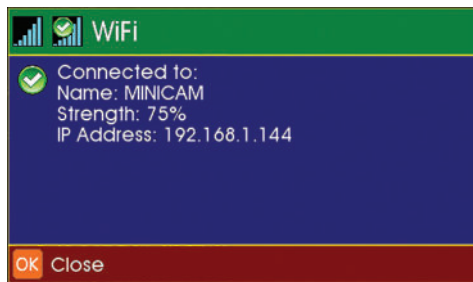
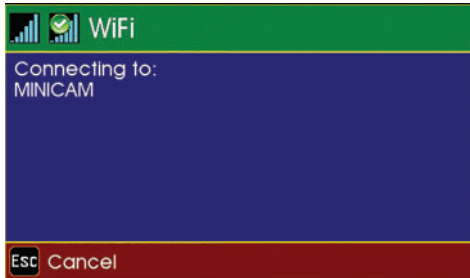
5 Select the required network form the menu.



6 Select Connect F1 (Red Key) to connect to the selected network (you will have to type a WiFi password in if required).



- 7 Status screens will display the connection progress, followed by connection confirmation, signal strength and IP Address.



- 8 The main display screen (see page 31) shows the WiFi status icon at the bottom right-hand side of the sidebar.

WiFi NOT CONNECTED

Red cross indicates no signal



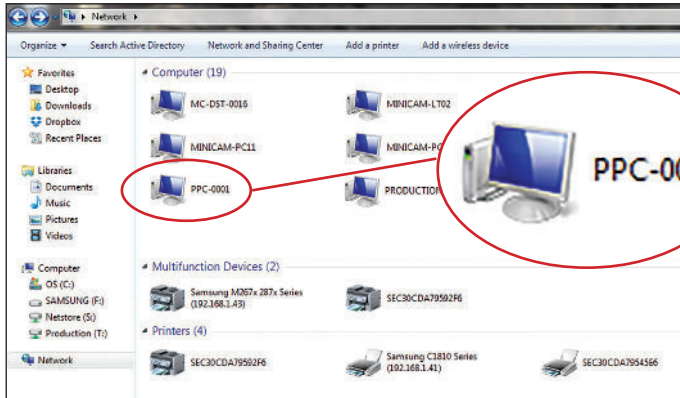
WiFi CONNECTED

Vertical blue coloured bars indicate signal strength

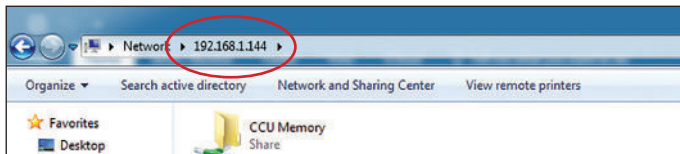


Connecting to your PC

Using *Explorer* in *Windows*® OS, the CCU may appear under the **Network Neighbourhood**. You can access your files directly.



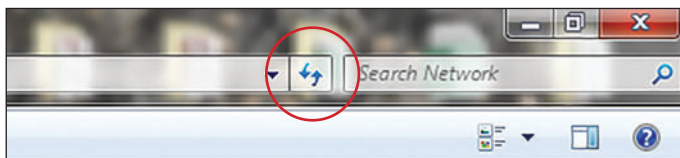
Alternatively, use the search bar in *Explorer* by typing \\ followed by the IP Address shown on your SOLOPro+ (Example - \\192.168.1.144)



This will then connect you to your SOLOPro+ control unit which will display a folder named *CCU Memory*. Double click on this folder to access all files currently on that control unit. You then can open any file to view video footage or still images and ProPIPE Reports or alternatively you can save them onto your PC.



NOTE: If the CCU is not displayed after the first search, try searching again by hitting the **Refresh** button on the menu bar





File Sharing



NOTE: To share the files over email or WincanWeb internet access is needed. Please connect to a Wifi with an internet connection before sharing files.

Email

- 1 Use the Gallery Browser  to select a file to be sent.
- 2 Navigate to the desired file, press OK and select the Share  option.
The Email option is only available for a single file, directories cannot be sent by email.
- 3 From the menu select the Email option. A text box with all the necessary data inputs fields will be displayed.
- 4 Enter Address, CC Address, Subject and Body text then press OK. The CCU will start the sending process. A message will be displayed with the sending progress, which will display Sent when the email has been dispatched.





NOTE: The most recent Address, CC Address and Subject are stored over the power cycle.



NOTE: The file to be shared over the email cannot exceed 10MB

WincanWeb

If the user has a *WincanWeb* account he can use it to upload *Wincan* Embedded projects.

- 1 Use the Gallery Browser  to select a WinCan project to be sent.
- 2 Navigate to a WinCan project, press OK.
- 3 Select the Share  option.
- 4 From the menu select the WincanWeb option. A text box with all the necessary data inputs fields will be displayed.
- 5 Enter Login and Password, then press OK. The WinCanWeb will start the sending process. A message will be displayed with the sending progress, which will display Sent when the upload has finished.





NOTE: To share using WincanWeb, WinCan catalogues must be installed on the CCU.



NOTE: Login and password are stored over the power down.

Share Status

The user can clear the status window displayed after the share process has been started and an appropriate form filled, without interrupting file sharing.

The share icon  will be visible in the right bottom corner until the Email or WincanWeb has finished sending. The progress can be also seen in the Share Status which can be accessed after pressing Gallery Browser . It will also inform the user in the case of a sending failure, which may happen if the internet connection has been interrupted or services are temporarily unavailable.



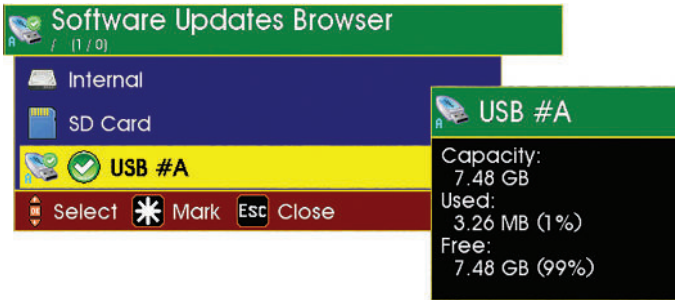
NOTE: To successfully share files, the CCU needs to remain on and connected to the internet until the sharing has finished.

Software Update

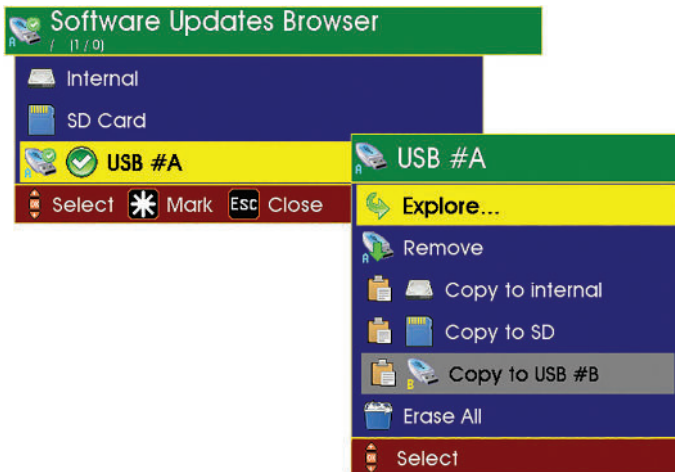
This feature allows the user to update the SOLOPro+ software, when available, in the field using removable media such as a USB memory stick or SD card.

- 1 Select Software Update from the Setup and Configuration drop-down menu page 61.

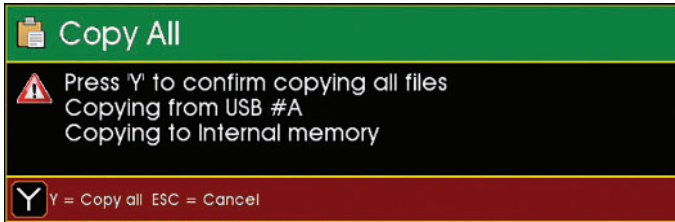
The Software Updates Browser will be displayed.



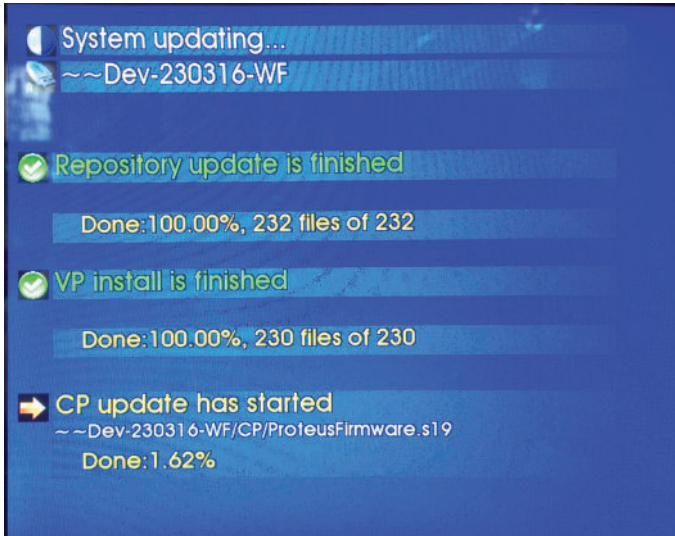
- 2 Select the removable media you are using and press OK. Highlight the update you want to install and press OK.



3 You will now be prompted to press Y confirm the copying the update.



The SOLOPro+ will now restart. On-screen text will show the status of the software update.



NOTE!

SOLOPro+ will not allow the user to use the Software Update feature if the internal batteries are less than 40% charged. This feature will then appear greyed out in the menu.

Service Centre

This menu option is for sole use by Minicam and its authorised dealers. As such, this option is password protected.

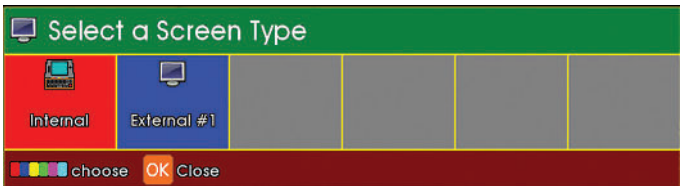
Screens Key

The brightness, colour and backlight intensity of the internal (CCU) and external monitors can be adjusted to suit the environment in which the unit is being viewed:

1 Press the Screens key.



Press F6 (Cyan key) Choose a Screen to select the Internal Screen (CCU) or an External Monitor



Select Internal or External




Press F1 (Red key) to display the LCD Backlight status bar



Use the Left Arrow cursor key to decrease the brightness or the Right Arrow cursor keys to increase the brightness.

Sonde Key

This feature allows the user to set the frequency of the Sonde transmitter.

- 1 Press the Sonde key 



The Sonde can be cycled through three states – OFF, PULSED, ON.

A symbol is displayed in the sidebar of the main screen indicating the current status and frequency of the Sonde:



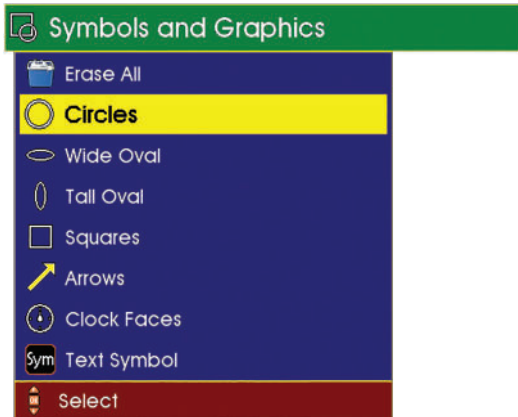
Symbols Key

Symbols and Graphics can be added to the recording, such as an arrow or circle, to highlight an area of interest.

1 Press the Symbols key



The Symbols menu will be displayed. Use the Up Arrow keys and Down Arrow cursor keys to highlight in yellow the symbol you require.



2 To add circles use the Up Arrow keys and Down Arrow cursor keys to highlight in yellow the size of symbol you require. Press OK.



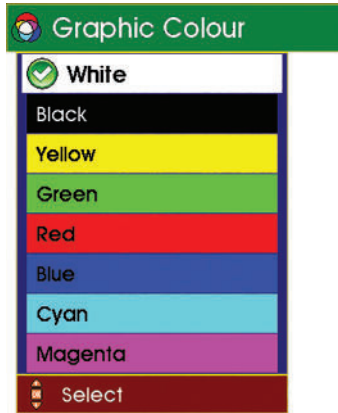
To add Arrows go to Step 4

To add Wide Ovals, Tall Ovals and Squares repeat 2 (above) selecting the required shape.

To add Clock Faces go to Step 6

To add Text Symbols go to Step 9

- 3 To colour shapes, use the Up Arrow and Down Arrow cursor keys to highlight the graphic colour you require. Press OK.

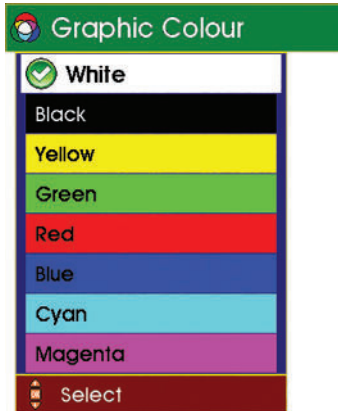


The shape will be displayed on screen.

- 4 To add arrows, use the Up Arrow keys and Down Arrow cursor keys to highlight the arrow direction you require. Press OK.



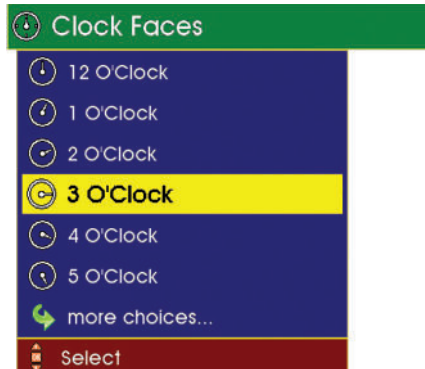
- 5 To colour arrows, use the Up Arrow keys and Down Arrow cursor keys to highlight the graphic colour you require. Press OK.



- 6 To add clock faces, use the **Up Arrow keys** and Down Arrow cursor keys to highlight in yellow the size of clock face you require. Press OK.



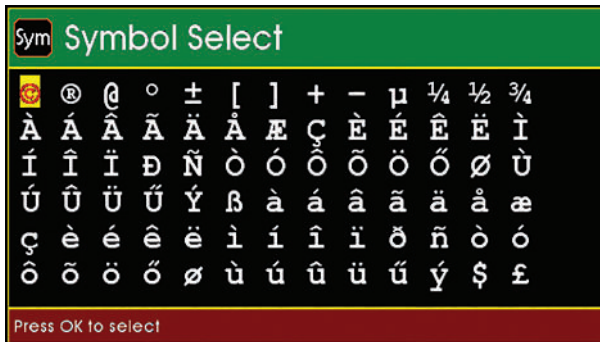
- 7 Use the Up Arrow keys and Down Arrow cursor keys to highlight in yellow the "time" of clock face you require. Press OK.



8 The clock face will be displayed.



9 To add Text Symbols, use the Left Arrow, Up Arrow, Right Arrow and Down Arrow cursor keys to highlight in yellow the symbol you require. Press OK.



Once a graphic (circle, wide oval, tall oval, square, arrow clock or text symbol) has been created and appears on screen, it can be moved and re-positioned on the screen using the cursor control Left Arrow, Up Arrow, Right Arrow and Down Arrow. When the desired position is located press OK to set the position.



NOTE! After pressing OK to position the graphic, it cannot be moved. The graphic will need to be erased and a new graphic created.

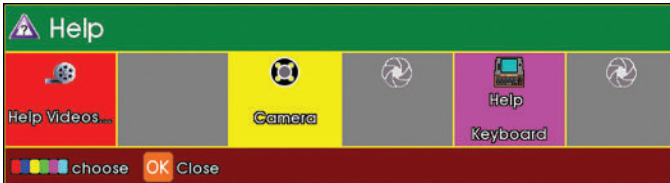
Help Key

At anytime, the Help key can be used to display a menu from which to navigate to the help options

1 Press the Help key



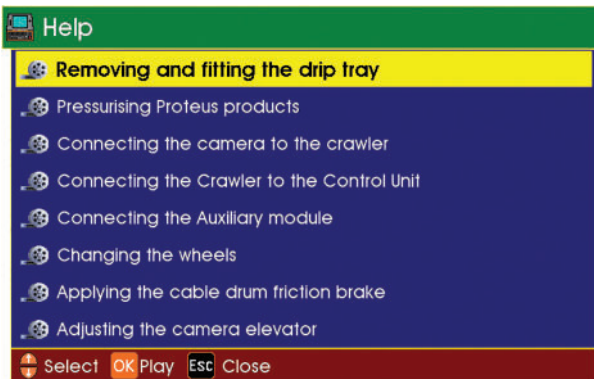
The help menu will be displayed:



Press F1 (Red key) to go to the "How To" Videos

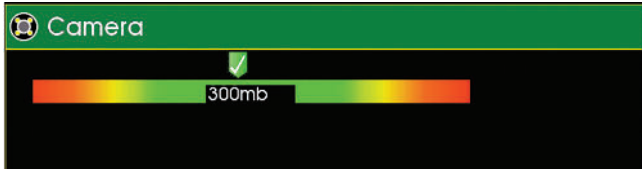


F1

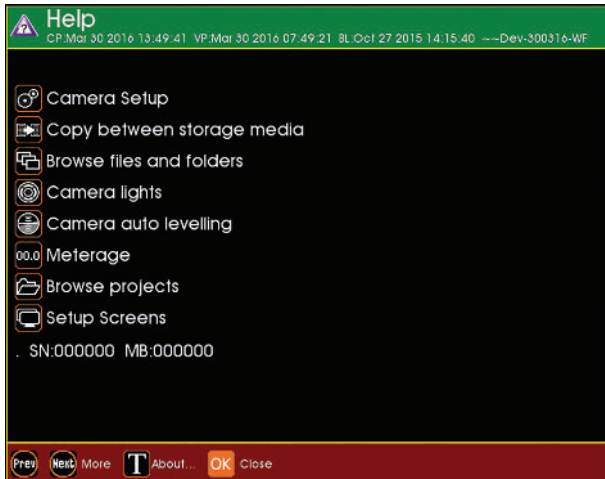


*Image for illustration purposes only.
Subject to change as videos are added to the system.*

Press F3 (Yellow key) to go to the Camera Help which will show the camera pressure:



Press F5 (Magenta key) to go to the Keyboard Help which will show the following menu from which to select a category:

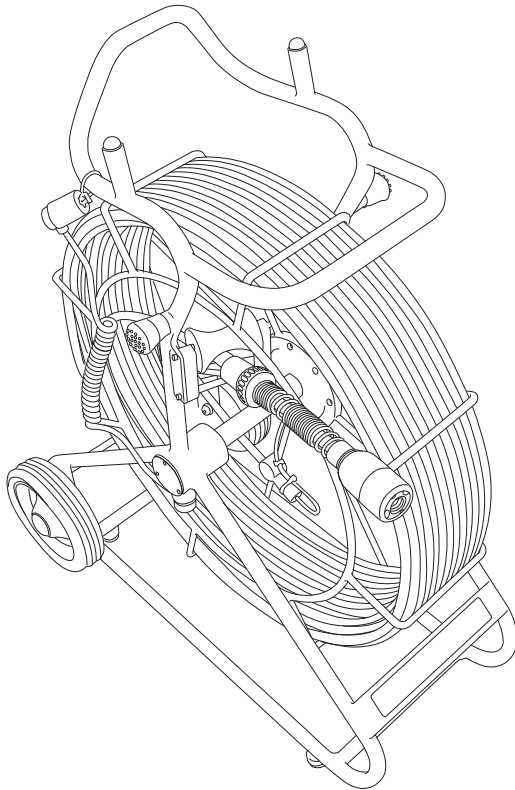


Technical Details - CCU210

Product ID:	CCU210
Dimensions:	435 x 250 x 140 (L x W x D)
Consumption:	Powder Coated
Weight:	3kg (6.6lb)
Controls:	Friction Brake
Temperature Range:	-10°C ~ +40°C
Environmental Protection:	IP54

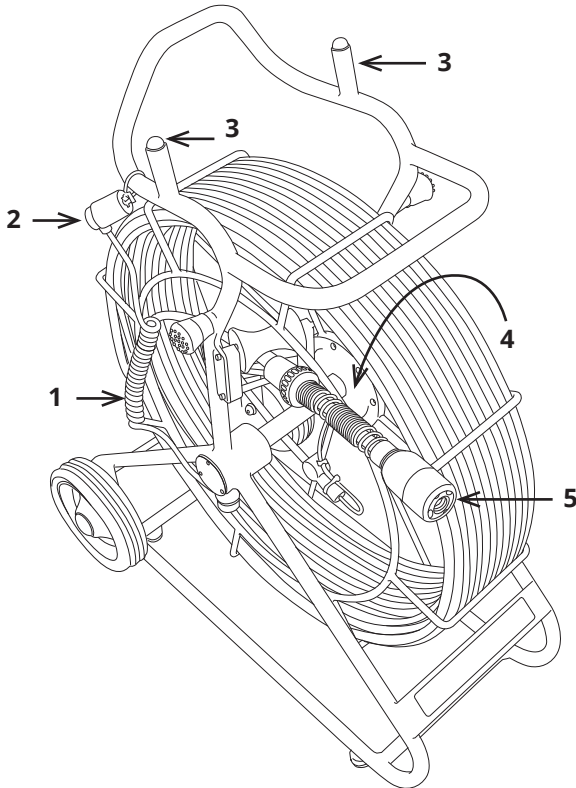
Coiler

The coiler supplied with the SOLOPro+ system features Minicam's unique Cow-horn shaped top section, enabling quick and easy fitting of the CCU to the coiler (see page 25). Available with rod lengths of 40m, 60m and 100m, the coiler also features a Friction Brake (see page 89) and has a Coiled Link Cable with protective dust cover. The interchangeable camera head allows the operator to use the Pan & Rotate camera - CAM026 (not shown) instead of the Self-Levelling Axial camera - CAM025 (shown). This provides great flexibility to meet demanding inspection requirements.



CAM025 is supplied as standard with SOLOPro+ Axial System
CAM026 is supplied as standard with SOLOPro+ Pan & Rotate System
CAM025 and CAM026 both supplied as standard with SOLOPro+ Duo System

Connections and Descriptions



- 1 Coiled Link cable (shown) or Extension Reel Cable (not shown) plugs directly into the CCU.
- 2 Protective Dust Cover.
- 3 CCU Location Pins.
- 4 Friction Brake.
- 5 Self-Levelling Axial camera -CAM025 (see opposite)



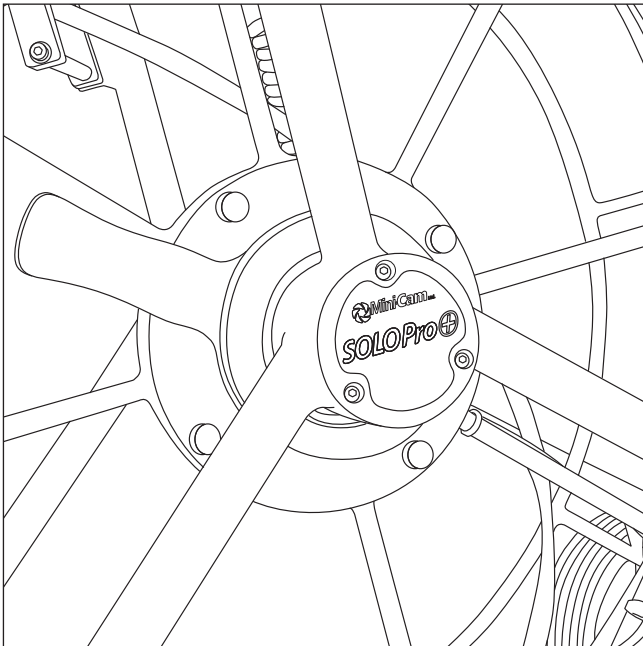
NOTE!

The CCU can power the coiler without the use of External Charger SPP-PSU or Proteus Battery Pack BPP24.

Friction Brake

Using the friction brake is a simple one handed operation with 3 options:.

- 1 The brake can be fully locked
- 2 The brake can be unlocked
- 3 The brake can applied as a friction brake to avoid unwanted pay-off of the rod.



Information and Care

Cleaning

Ensure that the cable is thoroughly cleaned after each inspection. Use a wet rag when winding the cable rod back onto the coiler. Ensure the connector for the coiler is free from dirt and moisture.

Maintenance

Ensure that all screw threads and connections are free from dirt.



CAUTION!

High-pressure cleaners **must not** be used. It can cause considerable damage to the coiler, camera and other system components.

Cleaning agents or solvents **must not** be used. These can damage theseals and other materials on the system.

Only clean water should be used.



IMPORTANT!

KEEP ALL ELECTRICAL CONNECTIONS AND CONTACTS FREE OF DIRT, GREASE AND MOISTURE AT ALL TIMES.

Technical Details - SOLOPro+ 40m Coiler

Product ID:	SPP-040
Construction:	Welded Steel
Finish:	Powder Coated
Distance Counter Units:	Feet, Metres
Controls:	Friction Brake
Weight:	15kg (33lb)
Dimensions (L x W x H):	52 x 37 x 69cm / 20.4 x 14.5 x 27.1 inches

Technical Details - SOLOPro+ 60m Coiler

Product ID:	SPP-060
Construction:	Welded Steel
Finish:	Powder Coated
Distance Counter Units:	Feet, Metres
Controls:	Friction Brake
Weight:	20kg (44lb)
Dimensions (L x W x H):	69 x 37 x 89cm / 27.1 x 14.5 x 35.0 inches

Technical Details - SOLOPro+ 100m Coiler

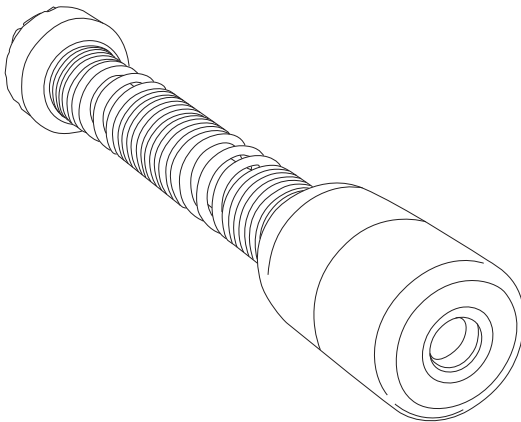
Product ID:	SPP-100
Construction:	Welded Steel
Finish:	Powder Coated
Distance Counter Units:	Feet, Metres
Controls:	Friction Brake
Weight:	30kg (66lb)
Dimensions (L x W x H):	80 x 37 x 100cm / 31.4 x 14.5 x 39.3 inches

CAM025 – Self Levelling Axial Camera

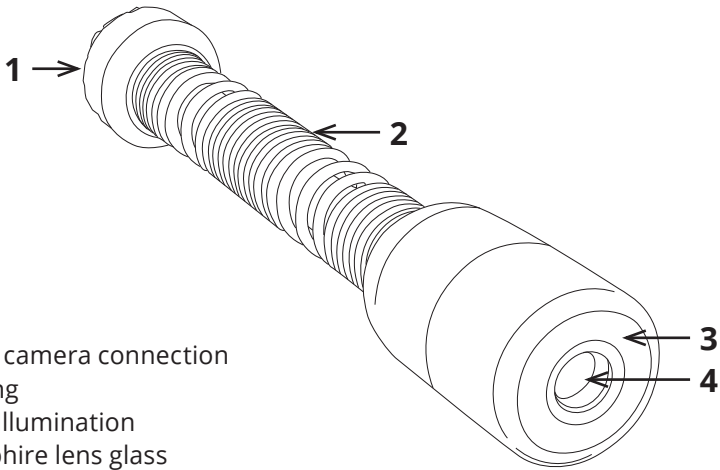
The camera module CAM025 provides a high resolution, colour, self-levelling camera for the SOLOPro+ platform. It has the following features:

- 1/4in colour CCD with DSP (Digital Signal Processor)
- Powerful 4 LED lighting with narrow beam width lenses
- Auto-levelling
- 470 HTVL Resolution
- Sensitivity <1.0 lux
- Illumination intensity adjustable to 12.5K lux at 150mm
- Pipe compatibility 50mm (2in) and up

The camera module is pressure-tested up to 1bar. It is suitable for inspections up to 10m water depth.



Connections and Descriptions



Information and Care

Pressurisation

The camera module is not pressurised.

Cleaning

Ensure the camera module is thoroughly cleaned after each inspection. Ensure the connectors are free from dirt and moisture. Always fit the protective cap immediately after disconnecting the camera module from the system.

Maintenance

Ensure that the camera connector is free from dirt.



CAUTION!

High-pressure cleaners **must not** be used. It can cause considerable damage to the coiler, camera and other system components.

Cleaning agents or solvents **must not** be used. These can damage the seals and other materials on the system.

Only clean water should be used.



IMPORTANT!

KEEP ALL ELECTRICAL CONNECTIONS AND CONTACTS FREE OF DIRT, GREASE AND MOISTURE AT ALL TIMES.

Technical Details CAM025

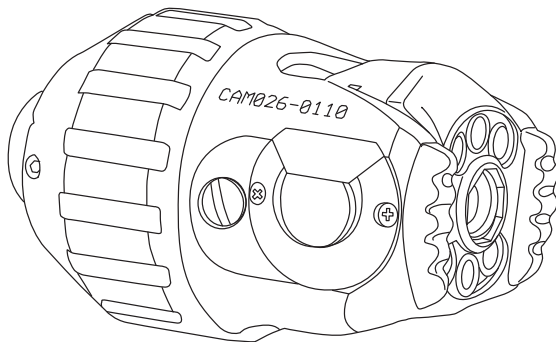
Product ID:	CAM025
Dimensions:	228 x 41mm (L x W)
Construction:	Stainless Steel
Pipe Compatibility:	50-225mm
Imager:	0.25in colour CCD DSP
Effective Pixels:	512px x 582px (PAL)
Resolution:	470 HTVL (enhanced)
Sensitivity:	<1.0 lux
Aperture:	FOV: F2.5 / 75°
Power Consumption:	4W
Weight:	589g (1.29lb)
Temperature Range:	-20°C ~ +50° C

CAM026 – Pan & Rotate Camera Module

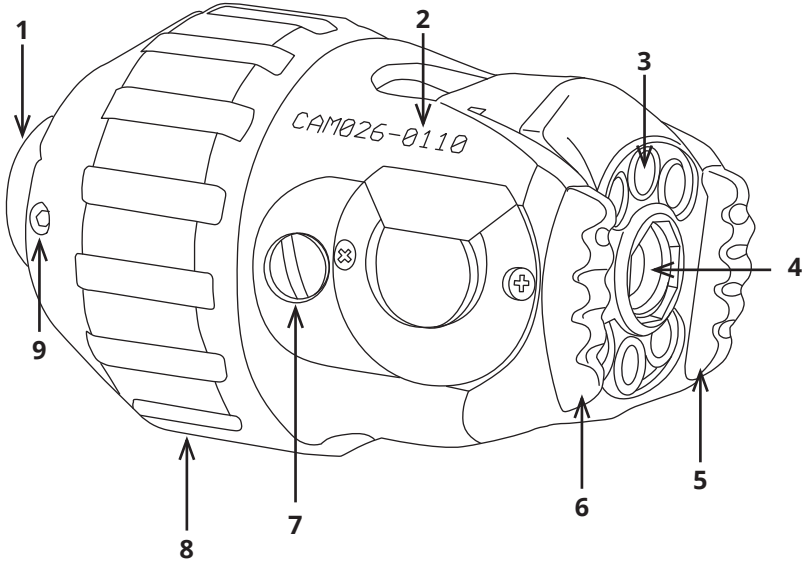
The camera module CAM026 provides a high resolution, colour, pan and rotate camera for the SOLOPro+ platform. It has the following features:

- High resolution colour CCD image sensor
- Powerful LED lighting with narrow beam width lenses
- Endless rotation range
- Panning range of +/- 135°
- Motorised focus control
- Internal pressure monitoring
- Impact resistant with user replaceable rubber protectors

The camera module is pressure-tight up to 1 bar. It is suitable for inspections up to 10m water depth.



Connections and Descriptions



- 1 Camera connector
- 2 Serial number location
- 3 LED illumination
- 4 Camera lens
- 5 Rubber protector
- 6 Rubber protector
- 7 Purge point
- 8 Camera protection skid
- 9 Camera protection skid screws (x6)

Pan & Rotate Camera Operation and Control

This section describes the operation and control of the Pan & Rotate camera on the SOLOPro+ system.

Basic camera operation

When the SOLOPro+ CCU is first switched on the joystick is active.


There is a set procedure to follow to operate the camera:

- Home
- Check Pressure

When using the joystick extra symbols are displayed on the right hand side of the display. These are not recorded on the video but provide a visual cue to the operator of the camera pressure and rotation.

A further two symbols are drawn on the top left of the display showing pan and rotation angles. These are recorded on the video.

Home

Press the Home key. 

The camera head returns to the home position. After the homing is complete the camera will now auto-level when in use until the joystick is moved. If the joystick is moved, press the Home key to home the camera and to enable auto-level again.



NOTE! The camera will only home when it is positioned within +/-45 degrees of horizontal. Otherwise it is unaware of which way is up! If the camera fails to home check the camera body position.

Likewise the auto-level feature will only work up to +/-45 degrees from horizontal.

Check Pressure

The camera pressure bar displayed on the right hand side of the display will either show a red bar with LO written within it or it will be green with the pressure written within it in mBar.

The Pan & Rotate camera must only be used when the bar is green.

To pressurise the camera see the pressurisation section below.



CAUTION! Attempting to record a video when the camera pressure is displayed LO in a red bar will display a warning on screen to the operator:

The camera pressure is low! Using the camera with low pressure will void the warranty and may damage the camera!


If you still wish to record with the camera now, press the Y key to confirm, or press ESC to cancel.”

If the camera is used with low pressure this information is recorded inside the camera and the warranty void.

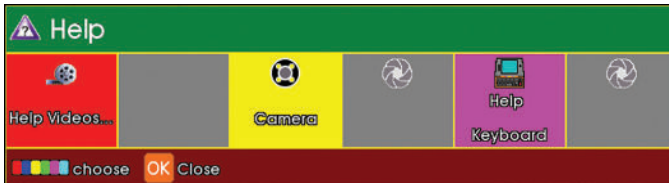
Pressing the menu key when the joystick camera control is enabled will automatically disable it to allow the operator control of the menu system. The operator must enable the joystick camera control manually afterwards.

Camera Pressurisation

To pressurise the Pan & Rotate camera it must be connected to the SOLOPro+. If not already done so, follow the instructions - Basic Camera Operation (opposite) to get the camera working first.

- 1 Move the camera with the joystick to allow easy access to the valve on the side.
- 2 Unscrew the protection cap from the camera and screw in the recharge valve.
- 3 Press the Help key 

The help menu will be displayed:




Press F3 (Yellow key) to go to Camera

This now gives a screen version of the live pressure gauge. The camera can now be pressured to approximately 500mBar with the pressurisation kit.

Do not over pressure! The CCU will warn for under/over pressure.

Driving the camera with pre-set movements

A range of pre-set camera movements are available to drive the camera e.g. drive a full 360° clockwise or anti-clockwise.

To view the full range of pre-set movements press the **Camera Sweep Key**  and select **Go** from the menu. Highlight the required movement and press **OK** to activate it.

Information and Care

Pressurisation

The camera module must always be correctly filled with CO₂ or Nitrogen. The control unit displays the internal pressure.

Cleaning

Ensure the camera module is thoroughly cleaned after each inspection. Ensure the connector is free from dirt and moisture. Always fit the protective cap immediately after disconnecting the camera module from the system.

Maintenance

Ensure that all screw threads and connections are free from dirt. Replace the rubber protectors when worn or damaged.



CAUTION!

High-pressure cleaners **must not** be used. It can cause considerable damage to the coiler, camera and other system components.

Cleaning agents or solvents **must not** be used. These can damage the seals and other materials on the system. Only clean water should be used.



IMPORTANT!

KEEP ALL ELECTRICAL CONNECTIONS AND CONTACTS FREE OF DIRT, GREASE AND MOISTURE AT ALL TIMES.

Technical Details CAM026

Product ID:	CAM026
Dimensions:	120 x 73 x 73mm (L x W x H)
Power Consumption:	10W
Weight:	0.85Kg (1.87lb)
Temperature Range:	-20°C ~ +50° C
Environmental Protection:	Pressurised
Internal Pressure:	0 to 500mb



PRO PIPE+

WinCan Embedded and ProPIPE+

Reporting Software

for Proteus™ and SOLOPro+ Systems

Version B

Principle

WinCan Embedded and *ProPIPE+* on the *Proteus™* and *SOLOPro+* CCUs allows you to create and maintain your surveys collected together as “Projects”.

Within a Project you can have many separate “Sections”. For example, a “Project” might be a housing estate, and each street within that housing estate could be a “Section”.

Each Project is stored in it’s own Folder in memory. The Folder contains all the information about that Project’s Sections, and their videos, photos, and report documents.

You can:

- n Have as many Projects as you want.
- n Add Sections to Projects whenever you want.
- n Create, close, save, reopen, and edit previously created Projects.
- n Reopen and edit Section Surveys, even after you’ve finished the Survey.
- n Create PDF and RTF report documents in a choice of graphical or textual styles.
- n Export your Projects Folder onto a USB memory device for later viewing on a PC.
- n Import and merge together Sections from Projects made on other CCUs.
- n Import *WinCan* Projects into *WinCan VX* on the PC.
- n Upload files from *WinCan* Projects directly from the CCU to the *WinCanWeb* cloud.

Basic Usage

The structure is:

- n You can have multiple Projects, each has it's own storage folder.
- n A Project can contain multiple Sections.
- n Each Section has Header Information and a Survey.
- n A Survey can have multiple Observations and Photos, and a Video recording.

The basic operating sequence is:









- n Select *WinCan* or *ProPIPE+* as your Project type.
- n Create a New Project or open an Existing Project.
- n Create a New Section in that Project, or open an existing Section.
- n Perform the Survey, first filling in the Header Information, then making Observations.
- n End the Survey.
- n Review and edit the Survey if you want to.
- n Create a report from a choice of different styles. You get an RTF report document and a PDF report document.
- n Export the Project to a USB memory device so you can view on the PC.
- n For *WinCan* Projects, these can be imported into *WinCan VX* on the PC.

Quick User Guide




Refer to this Quick User Guide when the CCU is directly available. The Quick Guide does not explain every screen, or key, or scenario, and relies on you physically seeing it operating on the CCU as you work through the guide.

In a separate section later in this document is a Detailed User Guide containing screenshots and more information.




Create a New Project

- n Press  then choose  or 
- n Press  to create a New Project.
- n Use  and  to select the survey standard.
- n Enter the Project Name and comments (use  to navigate between fields).
- n Press  to create the Project, then this New Project will be listed as available.




Choose Which Project to use

- n Use  and  to highlight the Project Name you require and then press . This then opens the Project for you to create your Sections.





Create a Section in the Project



- n Press  then  to create a New Section.
- n Enter the Section Name and comments then press  to create the Section.
- n Your newly created Section will then appear in your Project.


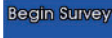


Select the Project Section to use

- n Use  and  to highlight the Section name you require and press . This will then open the Section for you to enter the Section Header details.



Enter the Section Header Information

- n Enter all relevant Section Header information. Anything marked with a  is required information which needs to be entered to be able to proceed to next page. There may be several pages of Header Information.
- n If you would like to display any of the Header Information on the live video 'project bar text', press . This then displays the  and  keys for you to select the information you would like to display by highlighting the desired Header Information





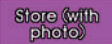
and pressing the relevant  and/or  key.

- n When all Header Information pages have been completed press  .
- n Now you can enter some Text Comments which will appear in the final report document along with the observations.
- n After entering your comments press  to prepare for starting the Survey.
- n The screen will say “Ready for Survey” and informs you to press the  ‘Record’ key when you want to begin. Press  now and this information box will disappear.
- n The screen will now display a live picture with your chosen Header Information showing on-screen.

Start Your Survey

- n Get your inspection equipment into position.
- n Start your recording by pressing the  key. A red recording symbol  will appear in the Status Box on the right of the screen which indicates your video recording and survey has begun. After a few seconds the on-screen video text will automatically disappear so that you can proceed with survey.

Create a New Observation

- n When you come to a point in your survey where you need to create a New Observation press  which will automatically pause the recording and show a Control Menu. Now you can either enter the Defect Code if you know it, or press to  select Survey Code Lookup which will give you a selection of Defect Category Folders to explore, then highlight the relevant Defect Code and press . Once you have entered or selected your Defect Code you fill in the information it asks for. Then press  to store the New Observation with *no photo* or press  to store *with a photo*.
- n Now you can continue your Survey. The system will automatically resume recording, and after a couple of seconds the observational text will disappear from the live picture.




NOTE!






If you move the camera before auto recording resumes you may notice a slight jump in the video playback!

- n Repeat these steps each time you wish to capture a new observation.


Review Your Survey

- n At any time, you can review the Observations in your survey.
Press  and select Review Survey. This will show you each observation you have created with the meterage displayed along with the captured image.

End Your Survey

- n To end the survey press  then in the control menu that appears select End Survey and press  . You will be prompted to Confirm End Survey by pressing  .
- n A summary of the Section which has just been completed is then shown.
- n If multiple surveys are being performed immediately within the same Project, press  and then press  to create a New Section, then repeat everything, starting from that New Section's creation.
- n Otherwise you can just create a report for that section if you wish to.

Create Your Report Documents

n To create an instant PDF report press . Then choose the style


of report that you want. The report is saved into the Project's folder along with the video and photos. You can copy the report onto a USB memory device using the Gallery Browser for later printing on a PC, or you can copy it to USB using the Project Export feature.

Detailed User Guide

Using Projects

Each Project is stored in it's own Folder in memory. The Folder contains all the information about that Project's Sections, and their videos, photos, and report documents.



Press the Projects  key, and the Project Type choice appears.

n Choose  or 

The Projects List appears

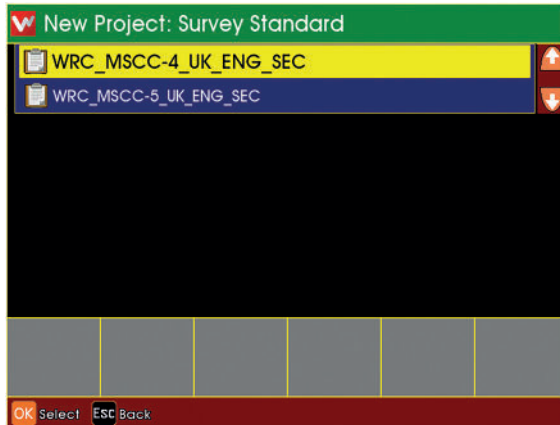




- n If you have any existing Projects, they will appear in the list.
- n If you have no existing Projects, the list will be empty

Choose New Project or an Existing Project

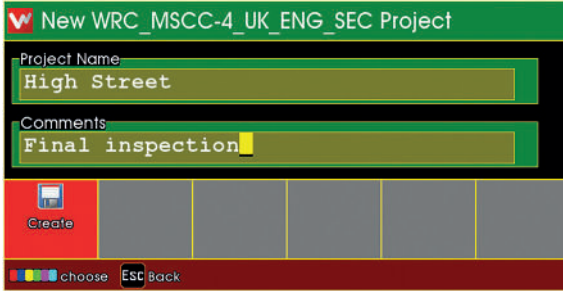
- To create a New Project, press  .
 - Or to open an existing Project, highlight it using the arrows  and then press  .
-


If you chose to create a New Project



- n Use the arrows  to select which Inspection Standard you wish to use, then press  .
- n Enter a Name for the Project.

- n You may also enter Comments for the Project of you wish.





- n Press  to create the Project.

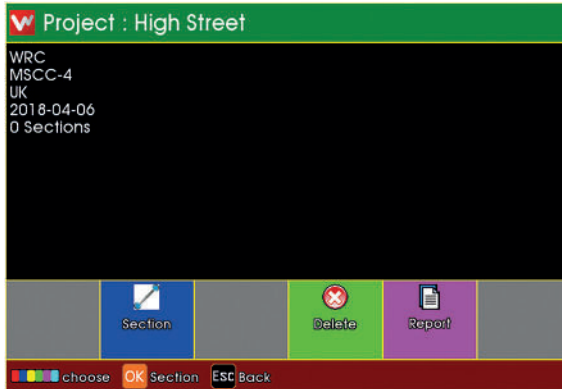
The Projects List appears


- n If you just created a New Project, it will appear in this list



- n Choose a Project to open
- n Highlight the Project using the arrows  and press .

The project is now opened



- n A summary of the Project is shown.
 - n A New Project will not yet have any Sections.
 - n An existing Project may already have Sections.
Press  to see existing Sections or create New Sections in the Project.
-

Using Project Sections




Each Project can contain either just one, or multiple Sections.

The list of Existing Sections is shown

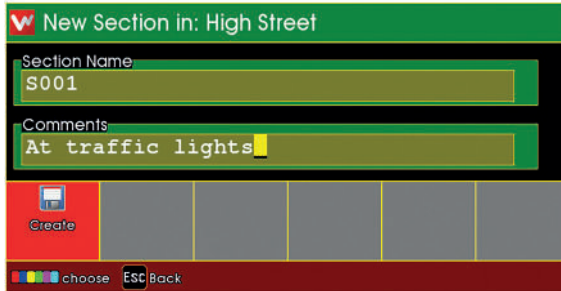



- n If the Project has any existing Sections, they will appear in the list.
- n If the Project has no existing Sections, the list will be empty.

You can choose to create a New Section in the Project, or open an Existing Section

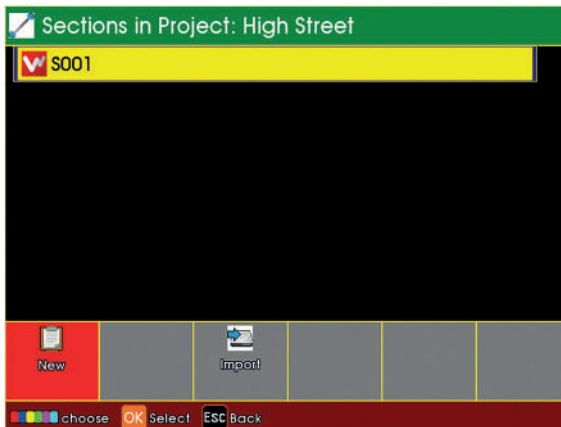
- n To create a New Section, press  .
- n Or to open an existing Section, highlight it using the arrows  and then press  .



If you chose to create a new section



- n Enter a name for the Section.
- n You may also enter comments for the Section of you wish.
- n Press  to create the Section.

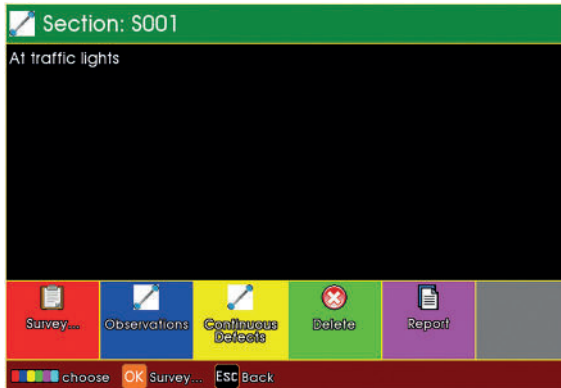
The Sections List appears




- n If you just created a New Section, it will appear in this list.
- n Choose a Section to open.
- n Highlight the Section using the arrows  and then press .

The Section is now opened

n A summary of the Section is shown.



If this is a New Section, you will need to perform the survey for the Section, so that you can create Survey Observations.

n Press  to begin performing the survey and create Observations.

If this is an Existing Section, it may already have had a survey performed for it, and will have existing Observations.

n Press  to review the existing Observations for this Section.

You can generate a Report Document for the survey Observations in this Section

n Press  to generate a Report Document

Preparing for the Survey

Entering Survey Header Information

If you chose to perform a survey for the Section:

The Survey Header Information appears

Section: S001 1/6

Job reference
Job001234

Location Code
FWY: A footway beside a road

Client
Council

Contractor's Job reference
CN5645


Name of Surveyor
Jim Smith

Street/Location
High Street

Means: Mandatory information that must be provided

Save&Close Free Text More...

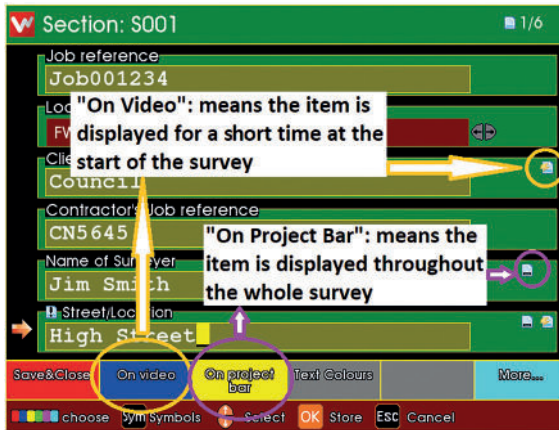
choose Symbols Select OK Store ESC Cancel

- n Type in, or select, the appropriate information for the survey.
- n Anything marked with a  is mandatory information that must be provided.
- n There may be several pages of Header Information.

For each Header Information item, you can choose whether

- n it is displayed briefly onto the camera picture "On Video" at the start of the survey.
- n you would like it displayed constantly "On Project Bar" throughout the whole survey.

Press the **More...** key, and the choices of the coloured keys change.

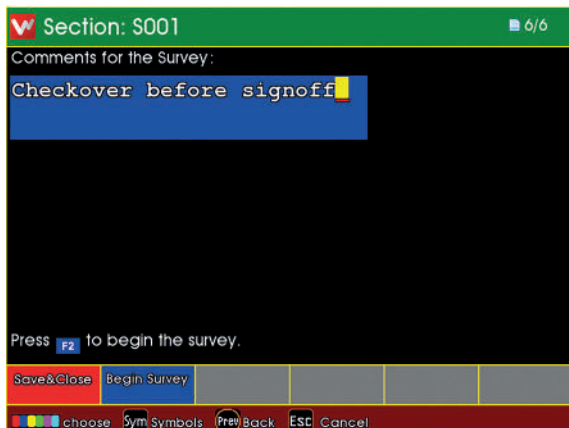


- n Press **On video** to toggle whether the Header Item is shown briefly at the start of the survey.
- n Press **On project bar** to toggle whether the Header Item is shown constantly throughout the survey.
- n Header Items can be both "On Video" and also "On Project Bar".
- n There is a limit to the number of Header Items that can be selected simultaneously.



After entering all the Header Information, you can enter some comments for the Survey

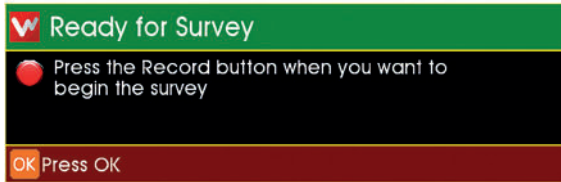
- n Type in some Survey Comments if you wish
- n Then press **Begin Survey** to prepare for performing the survey.



The system is now in Survey Standby, waiting for you to begin the survey.

n Video recording is ready, but is paused.

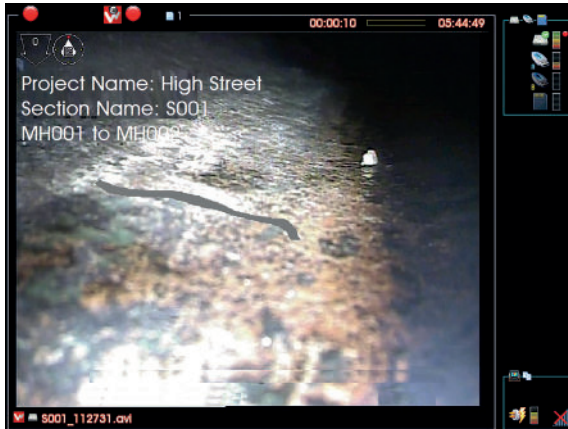
n Press the **OK** key, and position the inspection equipment ready for the survey.



Beginning the Survey

When you are ready to start video recording, press the  Record key.

- n Video recording starts.




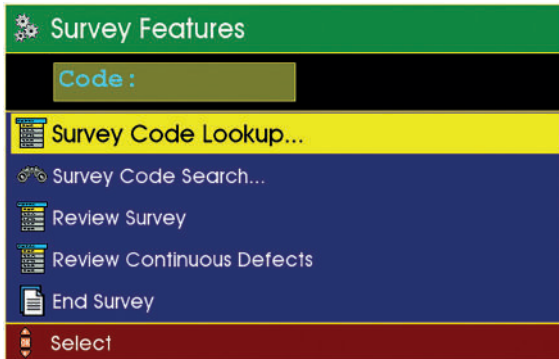
- n Your selected "On Video" Header Information text about the survey appears on the camera screen, and is recorded onto video.
- n After a short time, this information is removed.
- n You can now perform the inspection Survey.

Performing the Survey

Creating Defect Observations

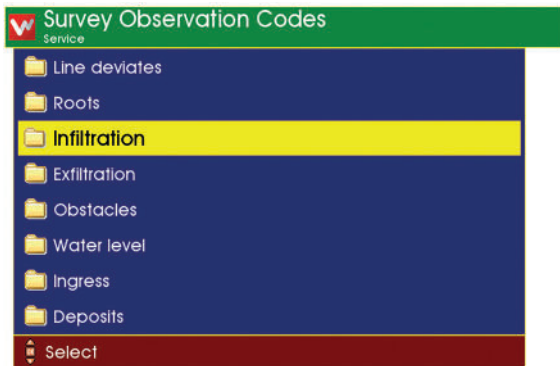
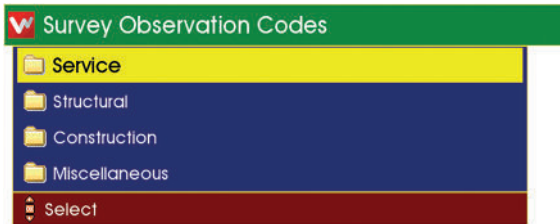
When you see a Defect, you can create an Observation for it.


Press the Projects  key, and the Survey Features menu appears.



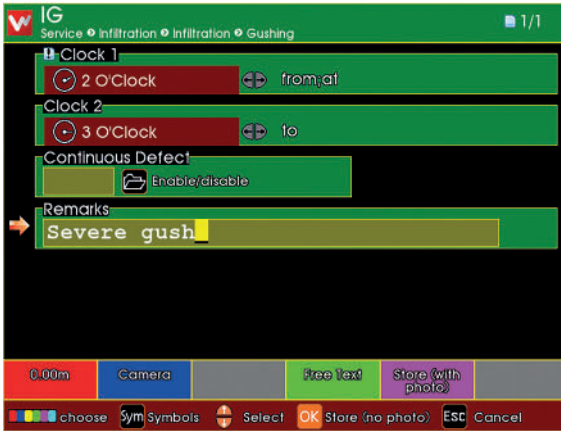
- n If you know the Defect Code, you can simply type it in.
- n If you don't know the code, you can search, or you can use the Lookup to find it.




If you chose to Lookup the Defect Code:
You see a list of the Defect Code categories



- n Use the arrows , **Esc**, and **OK** to browse the Defect Code categories to find the Defect Code that you require.
- n When you have found the Defect Code, press **OK**.

Enter the information for the Observation



- n Type in, or select, the appropriate information for the Observation.
- n Anything marked with a  is mandatory information that must be provided.
- n There may be more than one page of Observation Information.
- n When you have entered the information, you can store the Observation.
- n Press  to store without taking a photo.
- n Press  to take a photo then store.

If you chose to take a photo:


- n Your entered Observation Text information is shown on the camera screen

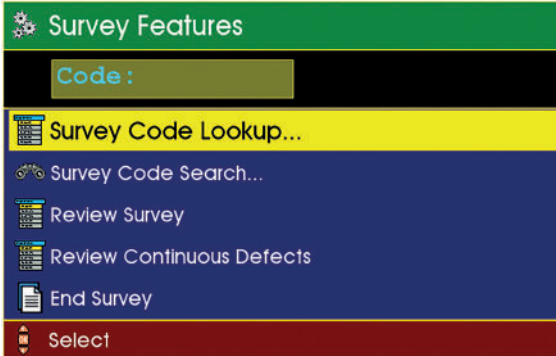


- n The system takes a photo, with this information on it.
- n After a short time, the information is removed.

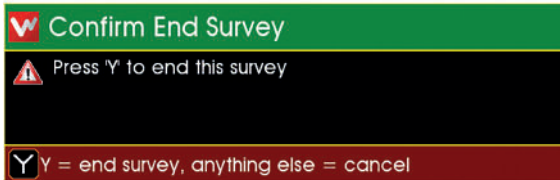
Video recording then restarts automatically and you can now move on to find the next Defect.

Ending the Survey

Press the Projects  key, and the Survey Features menu appears.



n Select End Survey and press .



You are asked to confirm you do want to end the survey.

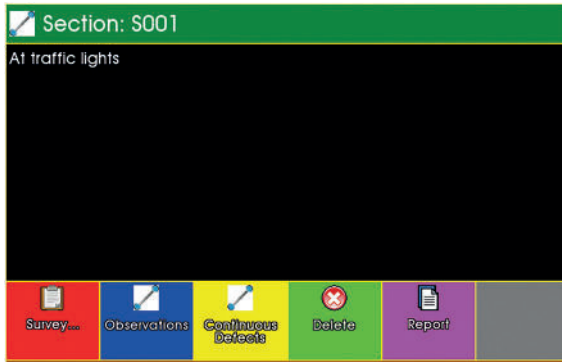
n Press  to confirm.

n Any other key cancels ending the survey.

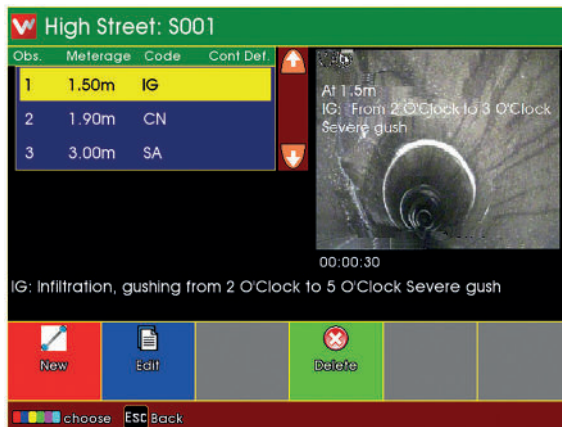
Reviewing the Survey

Viewing the Observations


When you have selected a Section, the Section Information is shown.





n Press  to Review the existing Observations for this Section.




The Section Observations are shown.

n Use the arrow keys  to select the Observation you are interested in. The screen shows the Observation information and the photo (if there is one).

n Press  if you want to Edit and change the selected Observation.

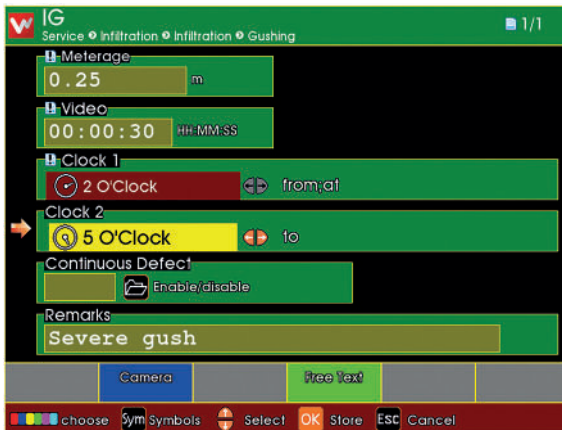
n Press  if you want to Delete the Observation (you will be asked to confirm the delete).

You can also create a New Observation, if one was missed when the Survey was being performed.


n Press  to create a New Observation.

Editing an Existing Observation

When you have selected the Observation to be edited, the Observation Information is shown.

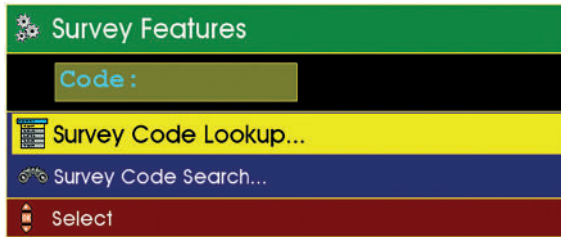


n Make any changes as you desire.

n Press  to store your changes to that Observation.

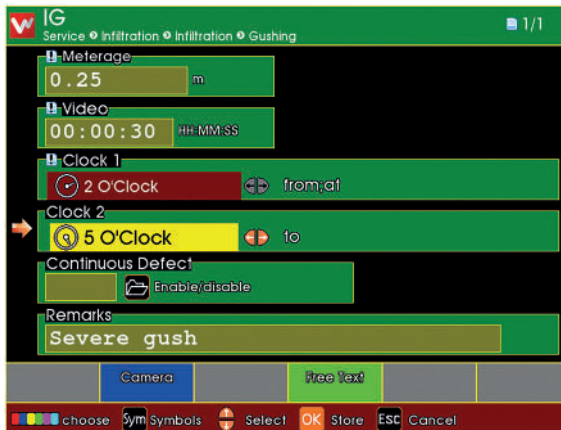
Creating a New Observation

When you have chosen to create a New Observation



- n First select the Defect Code for that New Observation.
- n This is done in the same way as when the Survey was originally performed.
- n Either enter the Defect Code directly, or use Search, or use the Lookup.

When you have selected the Defect Code for the new Observation, the Observation Information is shown.



- n Enter the information as desired.
- n Press **OK** to store this as a New Observation.

Your New Observation now appears added into in the Review List of Observations.

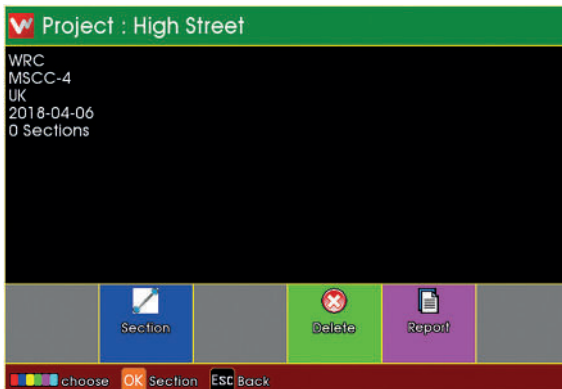



- n New created Observations don't have photos.
- n The Observations are sorted into ascending distance order.

Creating Reports

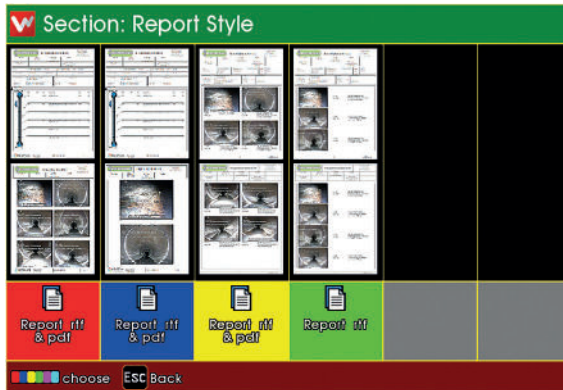
Creating Reports for the Whole Project


When you have selected and opened a Project, the Project Information is shown.



- n Press  to generate Report Documents for the whole Project.
- n Depending upon Project and Section complexity, this could take some minutes.

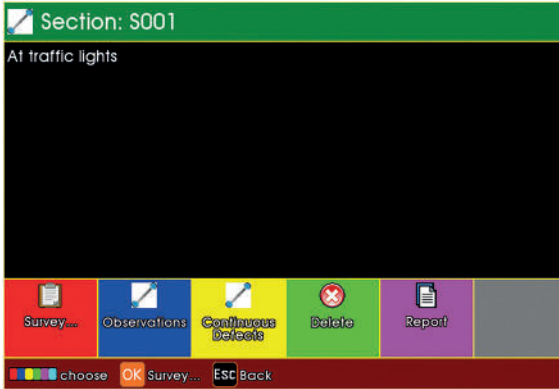
Previews of the various Report Styles are displayed.



- n Press the relevant coloured key to generate a report document of your chosen style.
- n Most reports are generated as both RTF and PDF documents.
- n The  style generates only RTF.
- n The report documents are stored into the Project's memory Folder, along with the Project's video and photo files.

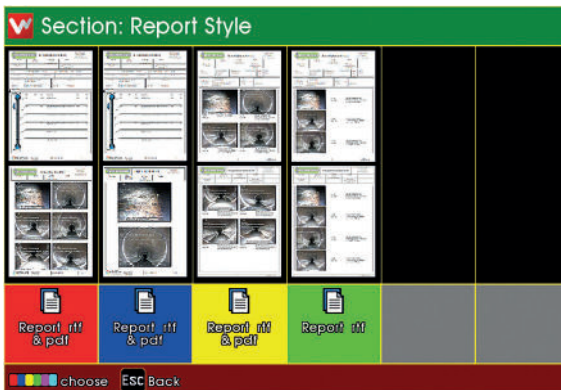
Creating Reports for a Selected Section

When you have selected a Section, the Section Information is shown.




- n Press  to generate Report Documents of this Section.

Previews of the various Report Styles are displayed.



- n Press the relevant coloured key to generate a report document of your chosen style
- n Most reports are generated as both RTF and PDF documents.

- n The  style generates only RTF.

- n The report documents are stored into the Project's memory Folder, along with the Project's video and photo files.

WEEE Statement

Under the European Union (EU) Directive on Waste Electrical and Electronic Equipment, Directive 2002/96/EC, products of electrical and electronic equipment cannot be discarded as municipal waste anymore and manufacturers of covered electronic equipment are obligated to take back such products at the end of their useful life. Minicam will comply with the product take back requirements at the end of life of Minicam products that are sold into the EU.

For disposal contact Minicam or the Minicam Partner in your country.



Information on Disposal for Business Users

Your SOLOPro+ CCU is marked with the symbol shown above. It means that used electrical and electronic products should not be disposed of in with general household waste. Contact your Local Council who will advise on the correct recycling procedure to follow.

In the European Union

Please contact Minicam or your nearest Minicam Service Centre who will inform you about the take-back of the product. You may be charged for the cost arising from take-back and recycling. Small products (and small amounts) might be taken back by your local collection facilities.

For Spain: Please contact the established collection system of your local authority for take-back of your used product.

Countries outside the EU: If you wish to dispose of your SOLOPro+ CCU, please contact your local authorities and ask for the correct method of disposal.

Batteries

As a producer of industrial batteries under the Waste Batteries and Accumulators Regulations 2009, we Minicam produce Lithium Ion batteries. We are obliged to take back free of charge, waste industrial batteries supplied to an end user for treatment and recycling. We are required to do this in any calendar year we place new industrial batteries on the market. If any of our customers or in certain cases other end users, require us to take back industrial batteries, they should contact us at:

Minicam Limited
Raven Locks
Ravenscraig Road
Bolton
M38 9PU
United Kingdom

Tel: +44 (0)1942 270524
Email: info@minicam.co.uk
www.minicamgroup.com

We will agree the necessary arrangements for the return, proper treatment and recycling of the waste industrial batteries.

Product Serial Numbers

Enter your product serial numbers below for future reference:

CCU	P	P	C	-							
COILER	S	P	P	-							
CAM025 Self Levelling Axial	C	A	M	0	2	5	-				
CAM026 Pan & Rotate	C	A	M	0	2	6	-				

Useful Information

UK Customers:
For service and repair contact Minicam
Tel: 01942 270524
Email: service@minicam.co.uk

International Customers:
For service and repair contact your local Minicam Approved Dealer



View Minicam "How To" videos on our YouTube Channel



Minicam Ltd,
Unit 33, Ravenscraig Road,
Little Hulton,
Salford,
M38 9PU
United Kingdom

Tel: +44 (0)1942 270524
Email: info@minicam.co.uk
www.minicamgroup.com



A **Halma** company

