



IMERYS

# SEWPER<sup>®</sup>

Unmatched H<sub>2</sub>S protection and performance for long-lasting sewage infrastructure protection



Here for generations



# Sewper<sup>®</sup> solutions

Built for H<sub>2</sub>S protection, engineered for durability.

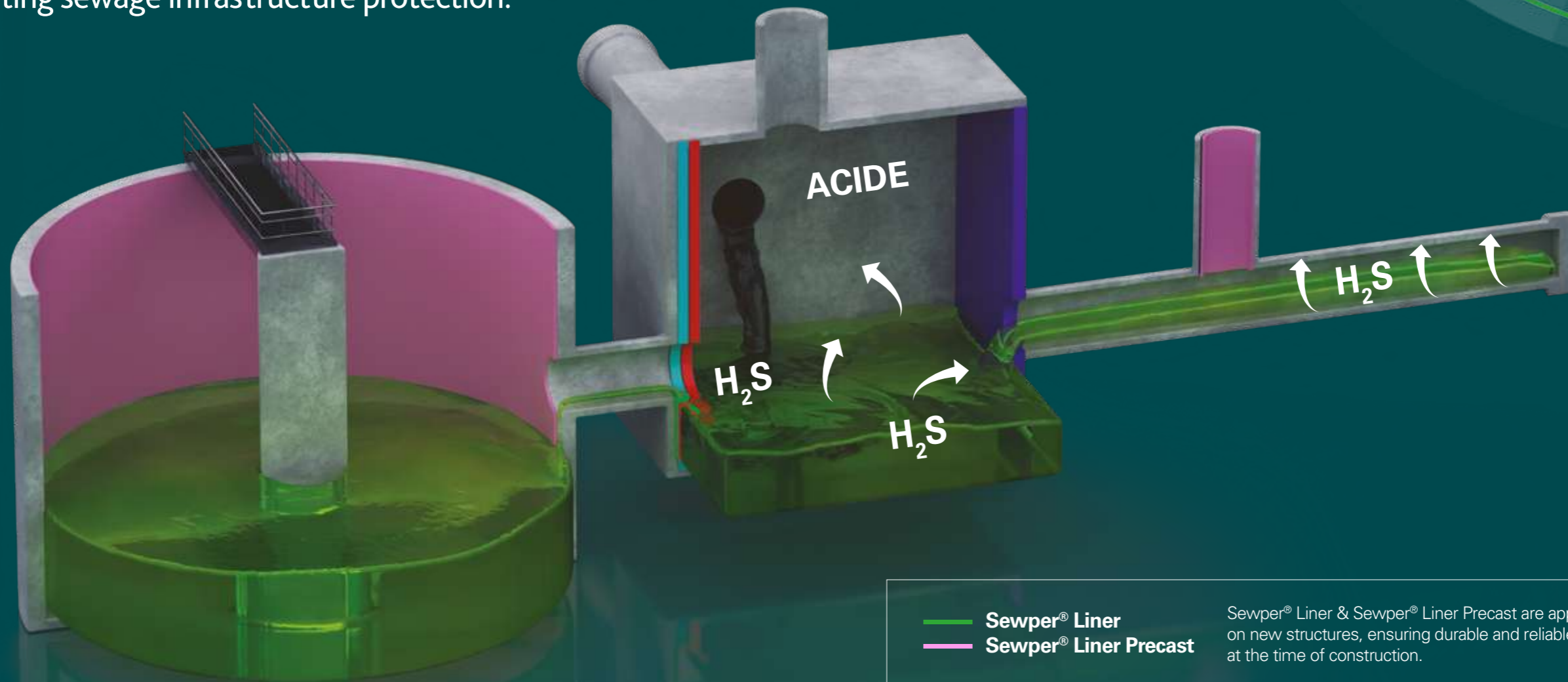

Unmatched H<sub>2</sub>S protection and performance for long-lasting sewage infrastructure protection.



With Sewper<sup>®</sup> Solutions, Imerys offers the ultimate solution for biogenic corrosion. Engineered for robustness and durability, Sewper Solutions excel in challenging conditions—resisting extreme chemical and mechanical stresses that compromise ordinary materials. These high-performance linings, backed by Imerys' expertise, extend the life of infrastructure while supporting sustainability goals, reducing the frequency and environmental impact of repairs. With Sewper, operators can count on sustainable, high-performance solutions to safeguard essential systems for the long term.

 Sewper<sup>®</sup> Liner  
 Sewper<sup>®</sup> Liner Precast

Sewper<sup>®</sup> Liner & Sewper<sup>®</sup> Liner Precast are applied on new structures, ensuring durable and reliable protection at the time of construction.

 Sewper<sup>®</sup> BackFill  
 SewperCoat<sup>®</sup>

Sewper<sup>®</sup> Backfill is applied first on the steel mesh covered structure to ensure structural repair before applying SewperCoat<sup>®</sup>. SewperCoat<sup>®</sup> is then applied as the outer layer to protect the structure from H<sub>2</sub>S corrosion.

 Sewper<sup>®</sup> Cast

Sewper<sup>®</sup> Cast is a structural concrete for new or existing structures, which can be poured vertically or horizontally and provides long-term protection against biogenic corrosion.

# SewperCoat®: Rehabilitation of H<sub>2</sub>S Biogenic Corrosion

Biogenic H<sub>2</sub>S corrosion severely damages in-service Wastewater Assets, reducing service life and threatening structural integrity.

With over 30 years proven performance, SewperCoat®'s unique mineral composition provides long-lasting, safe rehabilitation and allows repairs in live assets when needed.

## SewperCoat® 100% Calcium Aluminate mortar:

- Outstanding H<sub>2</sub>S Corrosion Resistance with proven track record
- Wet Spray formulation: no dust, low rebound; meeting confined space constraints
- Dry gunite formulation: ideal for long-distance applications
- Single Layer Monolithic Repair restoring structural integrity
- Fast Return to Service, as short as 1 hour for most situations
- Durable: satisfied owners around the world expect +50 years service

### Value, durability and peace of mind

Outstanding Sewper® durability removes repeated installation required with other approaches.

Typically, the installation of Sewper® often outlives other inert liner products on the market by up to three or four times.

#### Typical Service Life

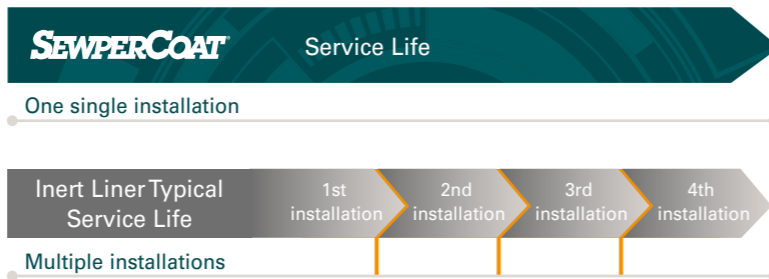

# Sewper® BackFill: Reinforcing and restructuring wastewater systems

Before protection or application of a protective layer against H<sub>2</sub>S corrosion, hydrodemolition and cleaning work is necessary. Structural repair is then essential.

Sewper® BackFill, with its rapid early strength development and its guaranteed compatibility with Sewper® solutions, allows the implementation of a complete and sustainable solution.

## Sewper® BackFill mineral solution benefits:

- Excellent compatibility with SewperCoat® and Sewper® Liner
- Complete mineral rehabilitation system guarantee
- Structural repair of sanitation networks (Class R4 – EN 1504-3)
- Wet spray application – easy to apply



### Application example:

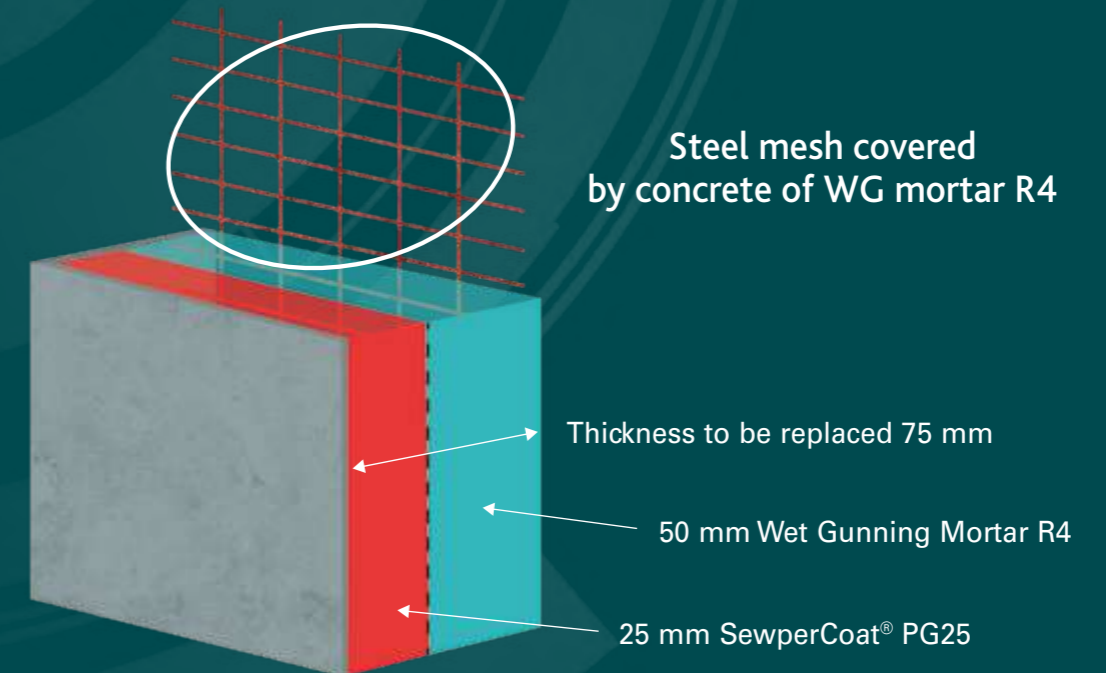

## Supporting a new era of sustainable construction

Sustainability is a catalyst for fundamental change in the construction industry. As a world leader in high-performance mineral solutions for Building & Infrastructure, Imerys is uniquely placed to unlock the sustainable potential of building materials to drive innovation and meet the changing needs of the industry and our planet.



# Sewper® Liner & Sewper® Liner Precast: Protection of new assets

Minimizing the total cost of ownership over long life is a key challenge in the design of new wastewater assets. Ensuring durable and reliable protection at the time of construction is the best approach.

When H<sub>2</sub>S Biogenic Corrosion is expected Imerys' innovative Sewper® Liner mineral solutions provide durable protection AND improved environmental performance.

## Sewper® Liner mineral solutions benefit:

- Outstanding H<sub>2</sub>S Corrosion Resistance: proven Calcium Aluminate Technology
- Fast spray application – easy to apply, protect large areas quickly
- Sustainable: environmental improvement vs. current practice
- Safe: no Volatile Organic Compounds, no dust, not flammable
- Bonds to new concrete surfaces
- Long lasting: reduced maintenance and longer inspection periods

## Sustainable solution

Environmental impacts are much lower for Sewper® Liner compared to an epoxy resin in a comprehensive comparative life cycle analysis conducted to ISO 14040/44 Standards.

\*Comparative Life Cycle Analysis as per 14040/44 Standards with third party external review: functional unit is a WWTP chamber, 5 mm Sewper® Liner Vs 1 mm BPA Epoxy with fiberglass reinforcement.

Sewper® Liner is a certified Imerys Pioneer product. This means it provides the highest environmental contribution to the downstream value chain, whilst also demonstrating a low environmental impact in its production phase compared to its economic value.

Key sustainability benefits:

- Reliable protective coating solution which provides a longer service life to wastewater assets, compared to epoxy resin which presents a high rate of premature failures over time.
- All environmental impacts are lower in the whole life cycle compared to epoxy resin.



# Sewper® Cast: Building a durable wastewater system

In the rehabilitation of a wastewater treatment plant/sanitation network when the damaged structural layer is too important or in new construction, pouring concrete saves time and guarantees the durability of the structure. Using the same Aluminates technology as other Sewper® solutions, Imerys offers Sewper® Cast, a structural concrete for vertical and/or horizontal casting.

## Sewper® Cast mineral solution benefits:

- Easy pouring and application (in concrete mixer or ready-mix delivery)
- Return to service between 6 and 8 hours after installation
- Excellent resistance to H<sub>2</sub>S corrosion, acids, and chemicals
- Very high resistance to abrasion and impact



Comparison for Waste Water Treatment Plant chamber application

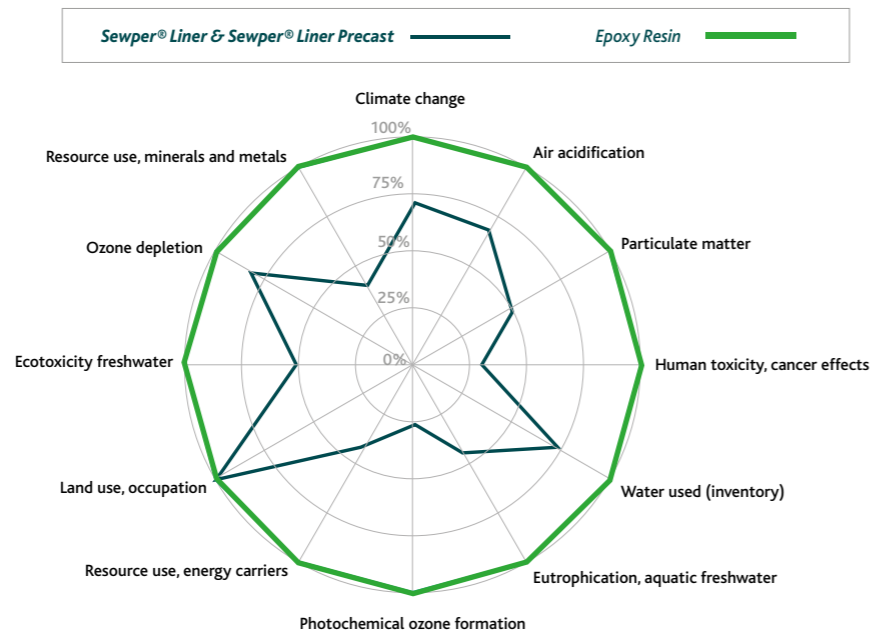

# The world leader in mineral-based specialties for industry



Nearly **24,000**  
customers



Sales in **126**  
countries



**€3.8bn**  
revenue

## At Imerys, we fulfill our role in society in a responsible way.

The technical expertise and innovative mindset of our people enable us to extract and transform minerals responsibly and in a sustainable way over the long term.

### Empowering our people

by reinforcing the maturity  
of our core values



We are introducing  
a new **Diversity, Equity  
and Inclusion (DE&I)** index<sup>1</sup>  
with the objective to achieve  
it at **100% by 2025**.

### Growing with our Customers

by ensuring ethical business  
and accelerating the development  
of sustainable solutions



We will **assess 75% of our product  
portfolio (by revenue) against  
sustainability criteria by 2025**.

We will rate the sustainability  
practices of **75% of our suppliers**.

### Caring for our Planet

by strengthening  
our commitments to preserve  
the environment



We will **reduce the Group's GHG  
emissions by 42%<sup>2</sup> by 2030**,  
aligning on the **1.5°C trajectory**.

We are reinforcing our  
environmental stewardship with  
**4 new objectives**.



Follow us on LinkedIn

Imerys – 43 Quai de Grenelle, 75015 Paris  
www.imerys.com

Notes: <sup>1</sup> For more information, go to [Imerys.com](https://www.imerys.com)  
<sup>2</sup> From 2021 base year